

Congratulations! We welcome you to the exciting world of motor home travel and camping. You will find it convenient and enjoyable to have all the comforts of home and still enjoy the great outdoors wherever you choose to go.

Your motor home has been carefully designed, engineered and manufactured to provide dependability as well as safety. Before sliding into the driver's seat, take a few minutes to become familiar with operations and features. This manual was prepared to aid you in the proper care and operation of the vehicle and equipment. We urge you to read it completely. In addition, spend some time with the dealer when you take delivery, you will want to learn all you can about your new motor home.

Your new motor home is covered by a factory warranty against defects in material and workmanship. This warranty should be validated at once and returned to the factory by your dealer.

Read and understand all instructions and precautions in this manual before operating your new motor home.

Throughout this manual, certain items are labeled NOTE, CAUTION and WARNING. These terms alert you to precautions that can involve risk to your vehicle or to your personal safety. Read and follow them carefully.

*NOTE: Indicates a special point of information.*

### CAUTION

Indicates that a failure to observe can cause damage to vehicle or equipment

### WARNING

This symbol is used to alert you to precautions that involve your personal safety as well as vehicle damage. Read and follow them carefully.

OWNER'S NAME
STREET ADDRESS
CITY AND STATE (OR PROVINCE IN CANADA)
MOTOR HOME SERIAL NUMBER
VEHICLE CHASSIS IDENTIFICATION NO. (VIN)
DATE OF DELIVERY TO FIRST RETAIL PURCHASER
VEHICLE MILEAGE AT TIME OF DELIVERY
SELLING DEALER NAME AND ADDRESS

<b>TANK CAPACITIES</b>	
<b>Vehicle Fuel Tank</b>	
Ford Chassis w/7.5L EFI Gas Engine	55 gal.
Ford Chassis w/7.3L Navistar Diesel Engine	55 gal.
<b>LP GAS TANK</b>	
All Models	14 gal./60 lbs.
<b>Fresh Water Tank</b>	
All Models	31 gal.
<b>Water Heater</b>	
All Models	6 gal.
<b>Black Water Holding Tank (Tank 1)</b>	
Model 429WQ (Toilet & Lavatory)	34 gal.
Model 429WU (Toilet & Lavatory)	34 gal.
Model 431WU (Toilet)	34 gal.
<b>Gray Water Holding Tank (Tank 2)</b>	
Model 429WQ (Galley & Shower)	31 gal.
Model 429WU (Galley & Shower)	31 gal.
Model 431WU (Lavatory, Galley & Shower)	34 gal.

### INTRODUCTION

Vehicle Chassis Manual.....	0-1
Motor Home Operations Manual (Binder).....	0-1
Before Driving .....	0-1
Service Assistance .....	0-2
Drinking and Driving.....	0-2
Reporting Safety Defects .....	0-2
Vehicle Certification Label.....	0-3
Exterior Feature Identification.....	0-4

### SECTION 1: SAFETY PRECAUTIONS

General Warnings .....	1-1
Driving .....	1-1
Fuel & LP Gas .....	1-1
LP Gas Leaks .....	1-2
LP Gas Alarm .....	1-2
Electrical .....	1-3
Loading .....	1-3
Maintenance.....	1-4
Formaldehyde Warning .....	1-4
Carbon Monoxide Warning .....	1-4
Carbon Monoxide Alarm .....	1-4
Emergency Exit Window.....	1-5
Fire Extinguisher.....	1-5
Smoke Alarm .....	1-5

### SECTION 2: DRIVING YOUR MOTOR HOME

Before Entering.....	2-1
Before Driving .....	2-1
Keys .....	2-2
Fuel Selection .....	2-2
Gasoline Fuel Fill.....	2-2
Fuel Tank Capacity .....	2-2
Starting and Stopping Engine .....	2-2
Parking Brake .....	2-3
Hazard Warning Lights.....	2-3
Door Locks and Handles.....	2-3
Entrance Step .....	2-3
Seats .....	2-4
Seat Belts .....	2-5
Child Restraints.....	2-6
Mirrors .....	2-6
Instrument Panel .....	2-7
Comfort Controls .....	2-8
Heating.....	2-8

Air Conditioning.....	2-8
Rear Auto Heater .....	2-8
Radio/Cassette Player .....	2-8
Auxiliary Start Switch .....	2-8
Auxiliary Battery Switch .....	2-8

### SECTION 3: IN CASE OF DRIVING

#### EMERGENCY

Hazard Flashers.....	3-1
Spare Tire.....	3-1
Tire Changing	
Safety Precautions.....	3-1
Wheel Nuts .....	3-2
Recovery Towing.....	3-2
Jump Starting .....	3-2
Connecting a Battery Charger.....	3-3
Engine Overheat .....	3-3

### SECTION 4: TRAVELING WITH YOUR MOTOR HOME

Loading the Vehicle.....	4-1
Roof Loading .....	4-2
Trailer Towing.....	4-2
Pre-Travel Checklist .....	4-3
Equipping For Travel	
Emergency Equipment Checklist.....	4-3
Quick Loading Checklist .....	4-4
Travel Tips.....	4-4
Severe Weather Information.....	4-5
Nighttime Driving.....	4-6
Mountain Driving .....	4-6
Campsite Selection .....	4-6
Blocking.....	4-7
Effects of Prolonged Occupancy .....	4-7
Humidity and Condensation .....	4-7

### SECTION 5: LP GAS SYSTEM

LP Gas Supply .....	5-1
Safe Use of LP Gas System .....	5-1
How LP Gas Works .....	5-1
Selecting Fuel Types.....	5-1
LP Tank System.....	5-2
Refilling Tank.....	5-2
Air in the LP Gas Tank.....	5-2
Traveling with LP Gas.....	5-2
Regulator.....	5-3
LP Gas Leaks.....	5-4
Winter Use of LP Gas.....	5-4

## TABLE OF CONTENTS

### SECTION 6: ELECTRICAL SYSTEMS

110-Volt AC System.....	6-1
External Power Cord (Shoreline).....	6-1
Power Control Center (Converter).....	6-2
Charging Section.....	6-2
Thermal Breaker.....	6-2
110-Volt Circuit Breakers.....	6-3
110-Volt Receptacles (Outlets).....	6-3
Ground Fault Circuit Interrupter (GFCI).....	6-3
Auxiliary 110-Volt Generator Operating Instructions.....	6-4, 6-5
12-Volt DC System.....	6-5
Automotive (Starting) Battery.....	6-6
Coach Battery.....	6-6
12-Volt Fuses.....	6-6
Battery Access (Storage).....	6-6
Battery Maintenance.....	6-7
Trailer Wiring Connector.....	6-8

### SECTION 7: PLUMBING SYSTEMS

Fresh Water System.....	7-1
Filling Water Tank.....	7-1
Fresh Water Tank Capacity.....	7-1
Water Pump.....	7-1
Water Pump Switch.....	7-1
Disinfection of Water Tank.....	7-1
External (City Water) Connector.....	7-2
Shower Valve Pressure Bleed-Off.....	7-2
Drainage System (Waste).....	7-3
Dumping Holding Tanks.....	7-3
Using On-Side Sewer Hook-Ups.....	7-3
Water Drain Valves.....	7-4
Holding Tank Capacities.....	7-6
Water System Drain Valve Locations.....	7-7 - 7-8

### SECTION 8: APPLIANCES AND INTERIOR FEATURES

Refrigerator.....	8-1
Range and Oven.....	8-4
Microwave Oven.....	8-5
Range Hood.....	8-5
Monitor Panel.....	8-6
Tank Leveling, Checking.....	8-6
Water Heater.....	8-7
By-Pass Valve.....	8-8
Motor Aid Water Heater.....	8-8
LP Gas Furnace.....	8-8
Roof Air Conditioner.....	8-9

TV Antenna.....	8-9
TV Signal Amplifier.....	8-10
Cable TV Hook-Up.....	8-10
Exterior Entertainment Center.....	8-11
Sleeping Facilities Overhead Bunk.....	8-11
Couch-Bed Conversion.....	8-11
Dinette/Bed Conversion.....	8-11
Fresh Water Toilet.....	8-12
Power Roof Vent.....	8-13
Slider Windows.....	8-13
Quartz Wall Clock.....	8-13
Coffee Maker.....	8-13

### SECTION 9: CARE AND MAINTENANCE

Roof.....	9-1
Underbody.....	9-1
Exterior.....	9-1
Waxing and Polishing.....	9-1
Stripes and Decals, care of.....	9-1
Interior Maintenance Upholstery, Carpeting and Draperies.....	9-2
Cabinets.....	9-2
Vinyl Wallboard.....	9-3
Tables and Countertops.....	9-3
Stainless Steel Sink.....	9-3
Bathroom.....	9-3
Doors and Windows.....	9-3
Window Roll-Up Shade Adjustment.....	9-3
Pleated Window Shade Adjustment.....	9-3
Vehicle Maintenance Chassis Service and Maintenance.....	9-4
Engine Access.....	9-4
Engine Cooling System.....	9-4
Tires.....	9-4
Suspension Alignment and Tire Balance.....	9-4
Windshield Washers and Wipers.....	9-4
Lights.....	9-4
Automotive 12-Volt Circuit Breakers.....	9-4

### SECTION 10: STORING YOUR MOTOR HOME

Preparing Vehicle for Storage.....	10-1
Cold Weather Storage (Winterizing).....	10-1, 10-3
Remove from Storage.....	10-4



Congratulations on the purchase of your new Winnebago Minnie Winnie motor home, which has been carefully designed, engineered and quality built by Winnebago Industries, Inc.

### OPERATOR'S MANUAL

Please read this operator's manual thoroughly. It was prepared in order to provide you with information necessary to properly and safely operate your new motor home.

This manual describes those instruments, controls and instructions which are unique to this motor home. For information regarding all other equipment, controls and instructions not described herein, we urge you to read the "Chassis Operating Guide" and the equipment manufacturer's information provided in your "Motor Home Operation Manual".

This manual should be kept in the vehicle at all times for personal reference. The operator's manual, motor home operation manual and chassis operating guide are to be considered permanent components of this vehicle. They should remain in the vehicle when sold to provide the next owner with important safety, operating and maintenance information.

*NOTE: The descriptions, illustrations, and specifications in this manual were correct at the time of printing. We reserve the right to change specifications or design without notice, and without incurring obligation to install the same on products previously manufactured.*

### CHASSIS OPERATING GUIDE

Throughout this manual, frequent reference is made to the vehicle chassis operating guide. The chassis guide is the operator's manual provided by the manufacturer of the chassis on which this motor home is built (i.e., Chevrolet, Ford, Freightliner, etc.). Consult the chassis guide for operating safety and maintenance instructions pertaining to the chassis section of the motor home.

### MOTOR HOME OPERATION MANUAL (Binder)

Your Motor Home Operation Manual contains information supplied by manufacturers of individual appliances and equipment installed in your motor home.

Consult this information regarding the operation and care of appliances, accessories and special equipment.

### OPTIONS AND EQUIPMENT

This model is available in several sizes and floorplans, so accessories and components may differ slightly between models. Some equipment described in this manual may not apply to your coach.

### BEFORE DRIVING

Before sitting in the driver's seat, always check around your vehicle to be sure you have proper clearance for maneuvering. If necessary, have a passenger help guide you out of a difficult parking space.

Although your coach features automotive conveniences like power steering and power brakes, driving a motor home is different from driving a car. A motor home is larger and heavier than an automobile, so it requires more stopping and passing distance, and more parking and maneuvering space than does a car.

Always be aware of the size of your motor home. The added height of roof air conditioners, TV antennas or luggage boxes may cause clearance problems around some tunnels, canopies and hanging signs. Know the height of your unit so you can observe posted clearance limits. Also, remember that some bridges, old ones in particular, may not support the weight of your motor home. Know the weight of your unit and observe any posted weight limits.

Remember: Always use your seat belt and be sure your passengers do so as well. We also advise making frequent rest stops while traveling to relieve stress on yourself, your passengers and your vehicle.

## INTRODUCTION

---

### SERVICE AND ASSISTANCE

Your dealer will be glad to provide any additional information you need, as well as answer any questions you might have about operating the equipment in your motor home. When it comes to service, remember that your dealer knows your vehicle best and is interested in your satisfaction. Your dealer will provide quality maintenance and any other assistance that you may require during your ownership of this vehicle.

If you need warranty repairs while traveling, however you may take your motor home to any Winnebago or Itasca dealership and they will assist you.

### WARRANTY

Your new vehicle is covered by a factory warranty against defects in material and workmanship. This warranty should be validated immediately and returned to the factory by your dealer. For additional information, see your "New Vehicle Limited Warranty" included with this vehicle.

### DRINKING AND DRIVING

Winnebago Industries supports the recommendations of the Presidential Commission on Drunk Driving.

- Exercise your good judgment and encourage others to do the same.
- Know the legal limits and do not exceed them.
- Also know your personal limits, which may be lower than the legal limits.
- Should you ever exceed your limits, find alternative transportation; call a cab, ask a friend to drive you home or call a family member to come and get you.

The presence of alcohol in significant levels in the blood increases the probability that the driver will be involved in an accident.

### REPORTING SAFETY DEFECTS

If you believe that your vehicle has a defect which could cause a crash or could cause injury or death, you should immediately inform the National Highway Traffic Safety Administration (NHTSA) in addition to notifying Winnebago Industries, Inc.

If NHTSA receives similar complaints, it may open an investigation, and if it finds that a safety defect exists in a group of vehicles, it may order a recall and remedy campaign. However, NHTSA cannot become involved in individual problems between you, your dealer, or Winnebago Industries.

To contact NHTSA, you may either call the Auto Safety Hotline toll-free at 1-800-424-9393 (or 366-0123 in Washington, D.C. area) or write to: NHTSA, U.S. Department of Transportation, Washington, D.C. 20590. You can also obtain other information about motor vehicle safety from the Hotline.

### VEHICLE CERTIFICATION LABEL

This label contains vehicle identification and other important reference information. The vehicle certification label is located on the sidewall to the left of the steering wheel, or on the driver's door. Never remove or destroy this label.

<b>MANUFACTURED BY</b> 		<b>INCOMPLETE VEHICLE MANUFACTURED</b> BY ① MOTOR CORP.	
② GAWR: _____		MONTH AND YEAR OF MANUFACTURE: ③ GVWR ④ LB _____ KG	
FRT _____ LB _____ KG RR. ⑤ LB _____ KG	SUITABLE TIRE AND RIM CHOICE TIRE _____ ⑥	RIM _____ ⑦	COLD INFLATION PRESSURE PSI _____ ⑧ KPA SINGLE _____ ⑨
THIS VEHICLE CONFORMS TO ALL APPLICABLE FEDERAL MOTOR VEHICLE SAFETY STANDARDS IN EFFECT ON THE DATE OF MANUFACTURE SHOWN ABOVE.			
SERIAL NO. ⑩ TYPE _____ ⑫		VIN _____ ⑪ MODEL _____ ⑬ COLOR _____ ⑭	

#### EXPLANATION OF DATA

1. Chassis manufacturer.
2. Chassis manufacture date.
3. Month and year of manufacture at Winnebago Industries.
4. Gross Vehicle Weight Rating: Total permissible weight of the vehicle, including driver, passengers, total cargo carried (including all liquids) and equipped with all options.
5. Gross Axle Weight Rating: Total permissible weight allowed for the front, intermediate\* and rear axles (listed in pounds and kilograms).
6. Suitable Tire Choice: Tires recommended to meet handling and safety requirements. When replacing any of the tires on your vehicle, always replace with a tire that meets these specifications.
7. Suitable Rim Choice: Wheel rims recommended to meet handling and safety requirements. When replacing any of the rims on your vehicle, always replace with a rim that meets these specifications.
8. Cold Inflation Pressure: Inflation pressures recommended (while Cold) for the tires originally equipped on your vehicle. These pressure levels must be maintained to assure proper handling, safety and fuel economy.
9. Intermediate\* and Rear Axle Wheel Configuration: Single or Dual.
10. Serial Number: This is the serial number assigned to the completed vehicle by Winnebago Industries.
11. Vehicle Identification Number (VIN): This number identifies the chassis on which the motor home is built.
12. Type: States the NHTSA designated usage classification for your motor home. MPV signifies a Multi-purpose Passenger Vehicle.
13. Model: Lists the Winnebago product model number of your vehicle.
14. Color: Signifies the color code number of the decor used throughout the vehicle. This number is necessary for ordering replacement cushions, curtains, carpet, etc.

\*Intermediate (INT) data applies only to Class-A models equipped with tag axle.

**EXTERIOR FEATURE IDENTIFICATION - Class C Motor Homes**

Typical model shown for illustration purposes only.

Actual locations of features depends on your model and option combinations

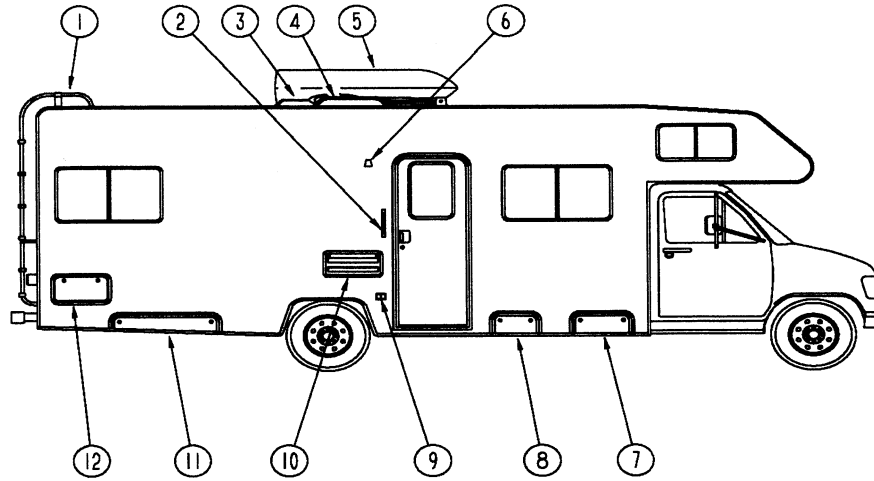

- |                         |                                  |
|-------------------------|----------------------------------|
| 1. Roof Access Ladder   | 7. LP Gas Tank Access            |
| 2. Assist Handle        | 8. Storage Compartment*          |
| 3. TV Antenna           | 9. 110-Volt Outlet               |
| 4. Refrigerator Vent    | 10. Refrigerator Access          |
| 5. Roof Air Conditioner | 11. Storage Compartment          |
| 6. Porch Light          | 12. Underbed Storage Compartment |

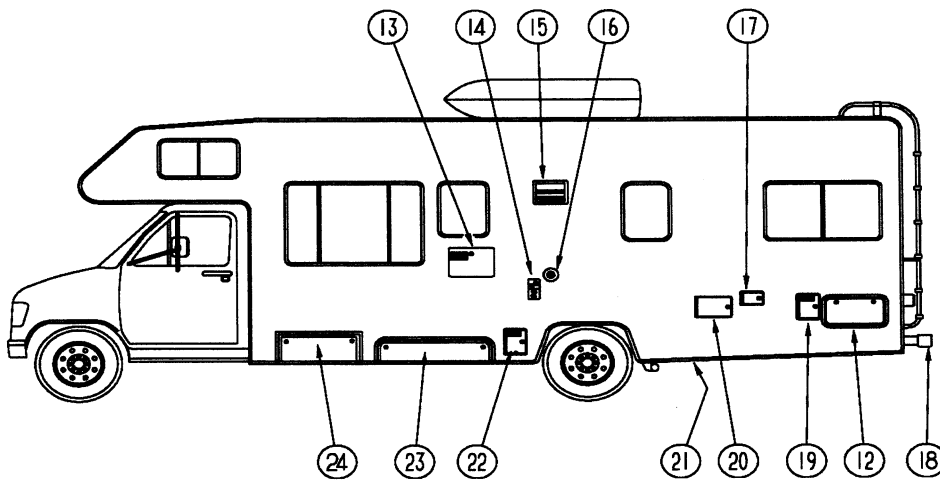

- |                               |                                     |
|-------------------------------|-------------------------------------|
| 13. Water Heater Access†      | 19. Fuel Fill Door                  |
| 14. Furnace Intake/Exhaust†   | 20. Sewage Drain Location           |
| 15. Range Hood Vent           | 21. Shoreline Compartment**         |
| 16. City Water Connection     | 22. Storage Compartment             |
| 17. Water Tank Fill Door      | 23. Auxiliary Generator Compartment |
| 18. Sewage Drain Hose Storage |                                     |

NOTE: Some equipment shown may be optional.

\*Coach battery compartment on some models

\*\*Also cable TV hook-up on some models

†CAUTION: Be careful. These features may become HOT while water heater or furnace are in use

Read and understand all instructions and precautions in this manual before operating your new motor home. Throughout this manual, certain items are labeled NOTE, CAUTION and WARNING. These terms alert you to precautions that can involve risk to your vehicle or to your personal safety. Read and follow them carefully.

*NOTE: Indicate special points of information.*

### CAUTION

Indicates that a failure to observe can cause damage to vehicle or equipment.

### WARNING

This symbol is used to alert you to precautions that involve your personal safety as well as vehicle damage. Read and follow them carefully.

Listed below are some safety precautions that must be adhered to. These precautions as well as others that involve damage to equipment are also listed in the appropriate areas in this manual.

### GENERAL WARNINGS

- Only seats equipped with seat belts are to be occupied while the vehicle is moving.
- Make sure all passengers have seat belts fastened in a low and snug position so the force exerted by the belt in a collision will be spread across the strong hip area. Pregnant women should wear a lap-shoulder belt whenever possible, with the lap belt portion worn low and snug throughout the pregnancy.
- All moveable or swiveling seats should be placed and locked in forward facing positions while the vehicle is moving.
- Never let passengers stand or kneel on seats while the vehicle is moving.
- Sleeping facilities are not to be utilized while vehicle is moving.
- Examine the escape window and be familiar with its operation, but do not use except in an emergency.
- Inspect the fire extinguisher monthly for proper charge and operating condition. This should also be done before beginning a vacation or any extended trip.

### DRIVING

- Do not attempt to adjust the driver's seat while the vehicle is moving.
- Do not adjust tilt steering in a moving vehicle.
- Do not operate the cruise control on icy or extremely wet roads, winding roads, in heavy traffic, or in any other traffic situation where a constant speed cannot be maintained.
- Use care when accelerating or decelerating on a slippery surface. Abrupt speed changes can cause skidding and loss of control.
- Driving through water deep enough to wet the brakes may affect stopping distance or cause the vehicle to pull to one side. Check brake operation in a safe area to be sure they have not been affected. Never operate any vehicle if a difference in braking efficiency is noticeable.
- Adverse weather conditions and extremes in terrain may affect handling and/or performance of your vehicle. Refer to your chassis manual for related information.

### FUEL & LP GAS

- All pilot lights must be extinguished and appliances turned off while refilling the fuel tank or LP tank.

## SECTION 1

### SAFETY PRECAUTIONS

# Winnie Winnie

- Never smoke while refilling vehicle fuel tank or LP gas tank.
- Avoid inhaling exhaust gases produced by burned gasoline, diesel fuel or LP gas in items such as the range, chassis engine, generator engine, refrigerator, furnace and water heater. They contain carbon monoxide, which is an odorless, colorless and poisonous gas.
- Do not bring or store LP gas containers, gasoline or other flammable liquids inside the vehicle because a fire or explosion may result. LP gas containers are equipped with safety valves which relieve excessive pressure by discharging gas to the atmosphere.
- Do not fill LP gas container(s) above 80 percent of capacity. Overfilling the LP gas container can result in uncontrolled gas flow which can cause fire or explosion. A properly filled container will contain approximately 80 percent of its volume as liquid LP gas.
- Never use an open flame to test for LP gas leaks. Replace all protective covers and caps on LP system after filling. Make sure valve is closed and door latched securely.
- Never connect natural gas to the LP gas system.
- When lighting range burners do not turn burner controls to "On" and allow gas to escape before lighting match.
- Portable fuel-burning equipment, including wood and charcoal grills and stoves, shall not be used inside the recreational vehicle. The use of this equipment inside the recreational vehicle may cause fires or asphyxiation.
- LP gas regulators must always be installed with the diaphragm vent facing downward. Regulators are equipped with a protective cover. Make sure that the regulator vent faces downward and that the cover is kept in place to minimize vent blockage which could result in excessive gas pressure causing fire or explosion.

- The following warning label is located in the cooking area to remind you to provide an adequate supply of fresh air for combustion.

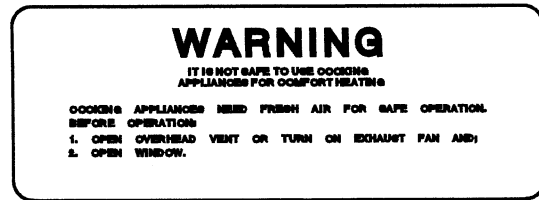

Unlike large homes, the oxygen supply inside a recreational vehicle is limited due to its size. To avoid danger of asphyxiation, provide proper ventilation when using the gas rangetop or gas oven. It is especially important that the gas oven and range top not be used for comfort heating. Danger of asphyxiation is greater when these appliances are used for long periods of time.

### LP GAS LEAKS

The following label is located in the vehicle near the range area. If you smell gas within the vehicle, quickly and carefully perform the procedures listed.

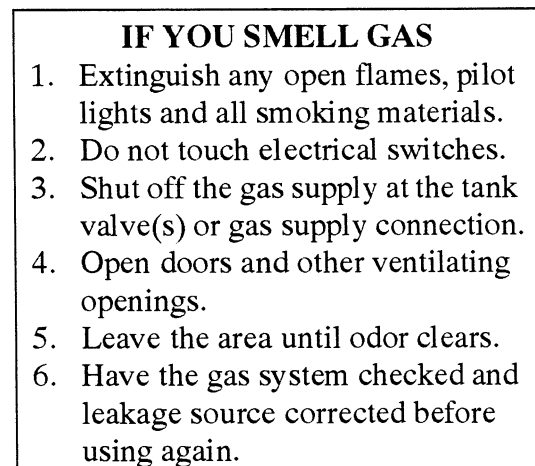

### LP GAS ALARM

Your coach is equipped with an LP gas detector which sounds an alarm if an unsafe amount of LP gas is present inside the coach. Because LP gas is heavier than air, the detector is located on a cabinet face near the floor of the coach.

A green light on the face of the alarm shows when the unit is active. The red button is used to reset the alarm.

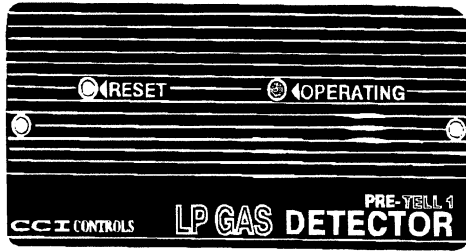

### IF THE ALARM SOUNDS

If the alarm sounds, do not touch any electrical switches. Immediately turn off the main LP tank valve and all LP appliances, open all windows and roof vents, and leave the coach until the alarm stops sounding.

If the alarm keeps sounding at regular intervals, a leak may be present. Contact your dealer or an LP gas service center to have the problem corrected before using the LP system again.

**WARNING**

Never use an open flame to test for gas leaks. When testing for gas line leaks with a soapy water solution, **DO NOT** use a detergent containing ammonia or chlorine. These substances may generate a chemical reaction causing corrosion to gas lines, resulting in dangerous leak conditions.

### POWER CONNECTION

The gas alarm is powered by the coach batteries. If the battery cable is disconnected from the batteries, auxiliary battery switch is shut off, or the fuse is blown, the alarm will not work. The LP gas alarm fuse is located on the power converter fuse panel shown on page 6-6.

Because the LP gas alarm is connected directly to the auxiliary battery, it is always drawing a small amount of current. Even though this current draw is slight, it could drain the coach battery during storage periods of 30 days or longer. We recommend turning the auxiliary battery switch off or disconnecting the battery cables from the auxiliary battery during extended storage periods to avoid discharge.

### FURTHER INFORMATION

See the manufacturer's information entitled "Your LP Gas Detector" in the operations manual binder for further instructions on nuisance alarms and care and testing of the LP gas detector.

### ELECTRICAL

- Careless handling of electrical components can be fatal. Never touch or use electrical components or appliances while feet are bare, while hands are wet, or while standing in water or on wet ground.
- Improper grounding of the vehicle can cause personal injury. Do not plug the utility power cord into an outlet which is not grounded and do not adapt the plug to connect to a receptacle for which it is not designed.
- Do not attach an extension cord to the utility power cord.
- Be sure that all electrical appliances to be used contain 3-prong plugs for proper grounding.
- Avoid overloading electrical circuits. Replace fuses or circuit breakers with those of the same size and amperage rating only. Never use a higher rated fuse or breaker.
- Use caution when handling or working near electrical storage batteries. Always remove jewelry and wear protective clothing and eye covering. Avoid creating sparks.

### LOADING

- Store or secure all loose items inside the motor home before traveling.
- Be aware of GVWR, GAWR and individual load limit on each tire or set of duals. (See "Loading the Vehicle" in Section 4.)
- Never load the motor home in excess of the gross vehicle weight rating or the gross axle weight rating for either axle.

## MAINTENANCE

- Do not remove the radiator cap while engine and radiator are still hot. Always check coolant level visually at the see-through coolant reservoir.
- Never get beneath a vehicle that is held up by a jack only.
- Do not mix different construction types of tires on the vehicle such as radial, bias or belted tires, as vehicle handling may be affected. Replace tires with exact size, type and load range.
- Do not attempt to start the vehicle by hot wiring.

## FORMALDEHYDE INFORMATION

### WARNING

Some components in this vehicle contain formaldehyde based adhesives which may release formaldehyde fumes into the air for an unknown period of time until total dissipation occurs. Individuals who are allergic to formaldehyde gas fumes may experience irritation to eyes, ears, nose and throat. Reaction in infants may be more severe. Although long range effects are not well understood, testing to date has not revealed any serious health effects in humans at the level of emission from these products.

*NOTE: To aid in dissipation, ventilate the vehicle by opening all windows and circulating the air with a fan.*

## CARBON MONOXIDE WARNING

### WARNING

Avoid inhaling exhaust gases, as they contain carbon monoxide, which is a colorless, odorless and poisonous gas.

If you suspect that exhaust fumes are entering the passenger compartment, have the cause determined and corrected as soon as possible. If you must drive under these conditions, drive only with **ALL WINDOWS FULLY OPENED**.

The best protection against carbon monoxide entry into the vehicle body is a properly maintained engine exhaust and ventilation system. It is recommended that the exhaust system and body be inspected by a qualified motor home service center.

- Each time the vehicle is raised for an oil change.
- Whenever a change in the sound of the exhaust system is noticed.
- Whenever the exhaust system, underbody or rear of the vehicle is damaged.

To allow proper operation of the vehicle's ventilation system, keep front ventilation inlet grill clear of snow, leaves or other obstructions at all times. **DO NOT OCCUPY A PARKED VEHICLE WITH ENGINE RUNNING FOR AN EXTENDED PERIOD.**

Do not run engine in confined areas, such as a garage, except to move vehicle in or out of area. When vehicle is stopped in an **UNCONFINED** area with the engine running for any more than a short period, adjust heating or cooling system to force outside air into the vehicle as follows:

1. Set fan to medium or high speed and vent control to air.
2. On vehicles equipped with air conditioning, set fan to medium or high speed and set control to obtain maximum vent air.

Rear windows should be closed while driving to avoid drawing dangerous exhaust gases into the vehicle.

## CARBON MONOXIDE ALARM

If your coach is equipped with a carbon monoxide (CO) alarm, it will be located on the ceiling in the bedroom area. The CO alarm is powered by a battery/sensor pack and is designed to detect toxic carbon monoxide gas fumes resulting from incomplete combustion of fuel. It will detect CO gas from any combustion source such as the fur-



nace, gas range/oven, water heater, refrigerator, chassis engine, and electric generator engine.

For further information, please read the manufacturer's guide included in your Motor Home Operations Manual binder. It includes information on precautions, operational testing, and battery/sensor replacement.

## EMERGENCY EXITS

### EMERGENCY EXIT WINDOW

Your motor home is equipped with an emergency exit window in the rear of the vehicle which functions as an escape exit in an emergency situation.

To open, pull on the red plastic loop at the bottom of the window until the rubber cord is completely removed. This allows the window to be pushed out.

Instructions for removal are also located on a label on the glass for quick reference and for passengers who may not be familiar with the exit. Be sure this label is never removed or destroyed.

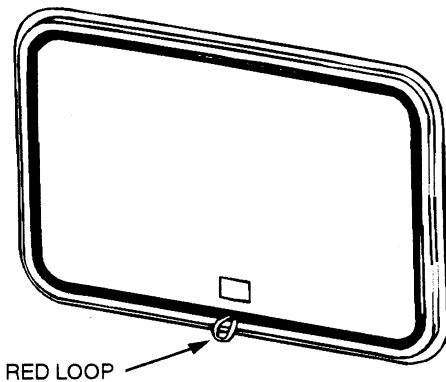

**WARNING**  
Use emergency window for emergency exit only. Do not test for proper operation.

If the cord is released by accident, but the glass remains in place, the cord can be replaced using a blunt instrument, preferably one made of plastic. We suggest you contact your dealer for assistance.

### WARNING

Use care when exiting emergency window, as broken glass may be present in the exit area.

## USING SLIDER WINDOWS AS EMERGENCY EXITS

Most slider windows along the side of the motor home can also be used as emergency exits, should the need arise. To use the windows as exits, first slide the window open, then slide the screen open.

## FIRE EXTINGUISHER

A dry chemical fire extinguisher is located near the floor by the side entrance door.

We recommend that you become thoroughly familiar with the operating instructions displayed on the side of the fire extinguisher or in the information supplied in your Motor Home Operations Manual binder.

We also recommend that you inspect the fire extinguisher for proper charge at least once a month in accordance with National Fire Protection Association (NFPA) recommendations as stated on the label. If the charge is insufficient, the fire extinguisher must be replaced.

### WARNING

Do not test the fire extinguisher by discharging it. Partial discharge can cause leakage of pressure or contents which would render the unit inoperative when needed. When using the fire extinguisher, aim the spray at the base of the fire.

## SMOKE ALARM

Your motor home is equipped with a smoke alarm located on the ceiling in the galley area. This alarm meets U.L. Standard 217 and NFPA Standard 74 for operation of smoke detection devices.

1. The smoke alarm should be tested for correct operation each time the vehicle is brought out of storage, before each trip, and at least once a week during motor home use. To test

## SECTION 1 SAFETY PRECAUTIONS

---

# Minnie Winnie

the electronics, firmly depress the button. To test that smoke reaches the sensor, blow smoke in a careful, fire-safe manner into your smoke alarm.

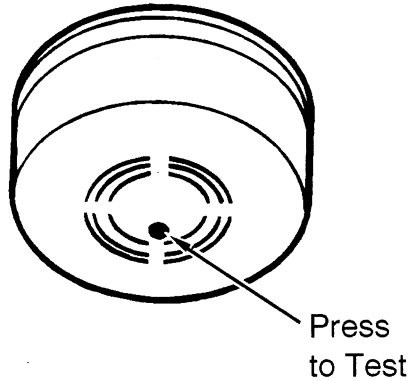

2. Your smoke alarm will not work without power. Never remove the battery to quiet the alarm. When your smoke alarm “beeps” about once a minute the battery is weak. Install a new battery immediately. Be sure to use only batteries specified in manual or on unit. Test unit after installing a new battery.
3. Clean and vacuum the openings on your smoke alarm once a month.
4. Do not open the smoke alarm or try to repair it. For replacement information see warranty in Owner’s Manual.
5. Smoke alarms have technical limitations and may not respond in all situations. FIRE PREVENTION is your best safeguard.

See your Motor Home Operation Manual binder for further information.

(See also Safety Precautions, Section 1 of this manual.)

*NOTE: See your Ford chassis operator's guide for information on starting the engine, operating the transmission, steering column controls descriptions of instrument gauges and other chassis related information.*

*Some items described in this section may be optional or unavailable on your coach.*

### BEFORE ENTERING YOUR VEHICLE

Before entering your vehicle, there are a few recommended procedures that will aid in your driving safety and equipment.

1. Be sure that the windows, mirrors and light lenses are clean and unobstructed.
2. Make sure all exterior lights operate properly.
3. Check tires for proper cold inflation pressures and inspect for any unusual wear.
4. Check wheel lug nuts for tightness.
5. Look beneath the vehicle for noticeable fluid leakage.
6. Check fluid levels and fill if necessary. This includes engine oil, transmission fluid, coolant, brake fluid, power steering fluid and windshield washer solvent.

#### WARNING

The transmission must be in P (Park) and park brake engaged while performing any checks or adjustments.

The engine should be shut off unless specifically required for a certain procedure.

7. Unhook and store sewer and water supply hoses.
8. Retract step.

9. Be sure that all of your cargo is secured in event of a sudden stop or an accident.
10. Check around your vehicle in all directions to assure that you have proper clearance.
11. Lower TV antenna.
12. Disconnect and store shoreline.

#### WARNING

Before driving your vehicle, be sure you have read the entire operator's manual and that you understand your vehicle's equipment completely and how to use the equipment safely.

### BEFORE DRIVING YOUR VEHICLE

Before preparing to drive your vehicle, here are a few recommended procedures that will add to your driving safety and enjoyment.

1. Be sure that you adjust the interior and exterior rear view mirrors to your driving preference.
2. Adjust the driver's seat for proper distance from foot pedals and steering wheel to allow for safety and ease in controlling your vehicle.
3. Place front seats in the forward facing position.
4. Be sure to fasten all safety belts to fit you comfortably, but tight enough to obtain the full safety of the belts.
5. Make sure all doors are completely shut and locked. When the doors are shut and locked, there is less chance of the doors flying open in event of an accident. It also prevents unintentional opening of doors and keeps intruders out of your vehicle.
6. Check to see that all gauges are operating properly.
7. Check the fuel level in the vehicle.
8. Be certain that the fire extinguisher is fully charged and secure in its mounting bracket.

**CAUTION**

Be sure hood and all compartment doors are latched securely before driving vehicle

**CAUTION**

Continuing to fill above this level may cause damage to the fuel/evaporative emission system.

**KEYS**

Your motor home is supplied with several sets of keys. In addition to the chassis manufacturer's ignition key, you receive keys for front doors, entrance door, and exterior compartment doors.

Each set of keys has an identification number, either a small metal tag or stamped into the key head. Record these numbers and keep them in a safe place. In case keys are lost or stolen, your dealer or a locksmith can provide you with duplicate keys or modify the locks.

**FUEL SELECTION**

Refer to your chassis operating guide for the manufacturer's recommendations on proper fuel selection.

**WARNING**

Modern fuel systems may build up pressure within the tank as the gasoline warms during use or in hot weather.

Under certain conditions, sudden release of this pressure when removing the gasoline cap can spray gasoline from the fuel fill opening, causing a possible hazard.

**GASOLINE FUEL FILL**

**REMOVING THE FUEL CAP**

When removing the gasoline cap, slowly rotate it **only far enough to allow pressure to release**. After any "hissing" sounds stop, continue removing the cap.

**FILLING THE TANK**

**Do not overfill the fuel tank.** Allow gasoline to pump into the tank until the auto-shutoff valve in the fuel pump nozzle stops the flow of fuel, indicating a full tank. This provides a pre-determined vapor space at the top of the tank to allow for expansion of the gasoline.

**Fuel Tank Capacity:**

Ford gas	55 gal.
Ford diesel .....	55 gal.

**REPLACEMENT FUEL CAPS**

To protect gasoline system from excessive pressure or vacuum, or from sudden pressure, replace lost caps with caps of the same design available from your dealer.

**STARTING AND STOPPING ENGINE**

Refer to your chassis operating guide for the manufacturer's recommendations on starting and stopping the engine.

**Brake-Shift Interlock**

Ford chassis are equipped with a brake-shift interlock safety feature. The shift lever cannot be moved from the Park position unless the ignition is ON and the service brake pedal is pressed.

*NOTE: On Ford chassis, if the brake light fuse is blown, the interlock feature will not work properly and an alternate method must be used. See your Ford Owners Guide for detailed instructions on what to do in this situation.*

**FUEL PUMP SHUT-OFF SWITCH**

Vehicles built on Ford chassis are equipped with an inertial type switch that shuts off the fuel pump in the event of collision. This switch must be manually reset to resume the fuel supply to the engine.

See your chassis operating guide for location and reset procedures for this switch.

*NOTE: It is possible to accidentally trigger the fuel pump shut-off switch by abruptly striking an object such as a curb or parking block. If your vehicle exhibits symptoms of running out of fuel immediately after such an occurrence, the fuel pump shut-off switch may need to be reset.*

Consult your Ford chassis operating guide for additional information.

### PARKING BRAKE

Never drive your vehicle with the parking brake set. This will reduce parking brake effectiveness and cause excessive wear. Consult your chassis operating guide in your Motor Home Operations Manual for operating instructions.

### HAZARD WARNING LIGHTS

See chassis operating guide for location of hazard flasher switch. See also Section 3 for further operating information.

### DOOR LOCKS AND HANDLES

*NOTE: Keys should always be removed when leaving the vehicle. Since doors can be locked without keys, make sure they have been removed from the ignition before locking the driver's compartment.*

The entrance door may be opened from outside the vehicle by pulling the door handle outward. To open the door from inside, pull outward on the door handle. When the door is locked, neither the inside nor the outside door handle can be operated.

### ENTRANCE DOOR LOCK AND HANDLE

The entrance door may be opened from outside the vehicle by pulling the door handle outward. To open the door from inside, pull outward on the door handle. When the door is locked, neither the inside nor the outside door handle can be operated. It can be locked and unlocked from the outside of the vehicle by inserting the key into the lock and turning.

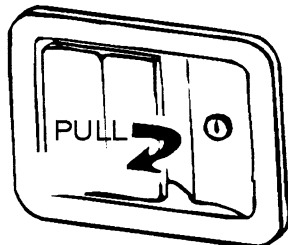

Entrance Door Handle - Outside

To lock the door from inside, rotate the lock levers as indicated. The deadbolt lock is for added security and should be used as a security night lock.

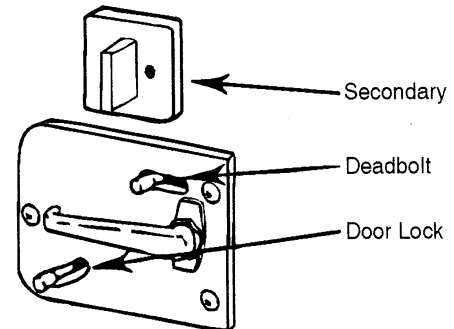

Entrance Door Handle - Inside

Lubricate the locks periodically with graphite to maintain good working condition.

#### CAUTION

When releasing security night lock, be sure to retract bolt before opening door latch to prevent drag on bolt pin. Instruct all passengers in operation of this door catch system as well as emergency exit window.

### DRIVER COMPARTMENT DOOR LOCK

Consult your chassis operating guide.

### ENTRANCE STEP

To extend the entrance step, lift up on the front of the step and pull out until it drops into position. To retract, lift up on front of step and push back until step locks into travel position.

#### WARNING

Do not use steps unless they are fully extended.

#### CAUTION

Always remember to retract the entrance steps before traveling or moving the vehicle.

## SECTION 2

### DRIVING YOUR MOTOR HOME

# Minnie Winnie

#### SEATS

The driver and co-pilot seats may be independently adjusted to suit individual preference. To move the seat forward or backward, lift the slide release paddle, located on the side of the seat, and exert slight body pressure in the direction desired.

The seats may be swiveled to provide easy entrance and exit. The swivel feature also allows the seats on some models to be turned toward the living area for additional seating while the unit is parked.

To swivel the seats: Lift the release lever, located on the side of the seat, and rotate seat. The seats are designed to lock only when returned to the forward facing position.

To recline the seats: Lift the reclining lever, lean back to desired incline and release the lever. To return to the upright position, lift the lever and lean body forward. Allow the seat to return to the desired position and release the lever.

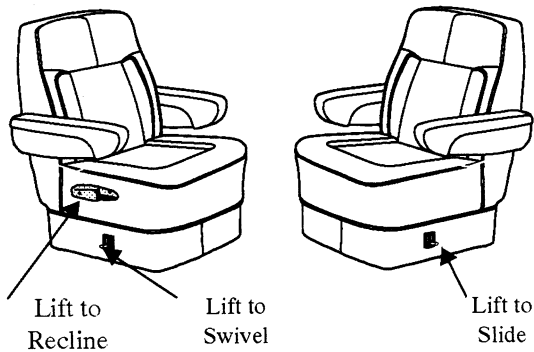

#### WARNING

Do not adjust driver's seat while vehicle is in motion.

After adjusting seat, always use body pressure to make sure slide and swivel locking mechanism have engaged.

#### ARM REST ADJUSTMENT

The driver and co-pilot seat armrests may be adjusted to rest at two different positions as shown.

Position 1 - Raise armrest, push in toward seat, and lower into position. This position would generally be used when the seat is in the upright position.

Position 2 - Raise armrest, pull outward from seat, and lower into position. You may wish to use this position when you recline the seat.

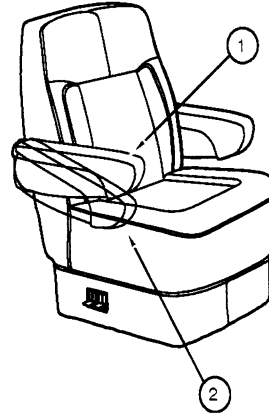

#### LOUNGE CHAIRS

The lounge chair has swivel and slider features to allow you to position the seat to your liking.

The swivel feature will lock in the center facing position for your safety while the vehicle is moving.

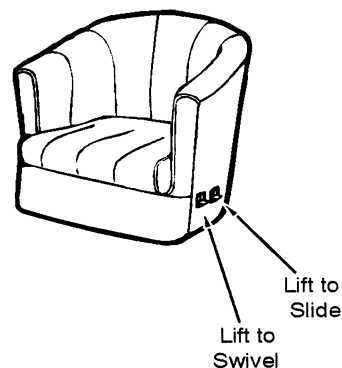

**To Swivel the seat:** Pull up on the swivel lever located on the side of the seat. The seat will lock into place whenever it reaches the center aisle facing position.

Always return the seat to the aisle facing position for proper use of seat belts while traveling.

**To Slide the seat:** Pull up on the slide lever located on the side of the seat. Slide to desired position and release lever.

### SEAT BELTS

Seats intended for occupancy while the vehicle is in motion are equipped with seat belts for the protection of the driver and passengers.

#### Lap Belts

The lap belts must be worn as low as possible and fit snugly across the hip area. Always sit erect and well back into the seat. To gain full protection of the safety belt, never let more than one person use the same safety belt at any one time, and do not let the safety belts become damaged by pinching them in the doors or in the seat mechanism. After any serious accident, any seat belts which were in use at the time should be replaced.

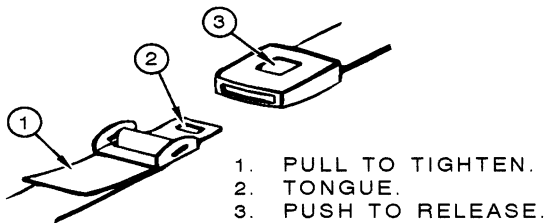

**Adjustment:** To lengthen belt, turn tongue at a right angle to belt and pull to desired length. To shorten, pull loose end of belt.

**To Fasten:** Be sure belt is not twisted. Grasp each part of the belt assembly and push tongue into buckle. Adjust to a snug fit by pulling the loose end away from the tongue.

**To Release:** Press button in center of buckle and slide tongue out of buckle.

#### WARNING

To reduce the risk of an injury in an accident, position the lap belt tightly and as low as possible across the pelvic area. Pregnant woman should be especially certain to wear the lap belt as low as possible across the pelvic area so there is no pressure on the abdomen.

Only seats equipped with seat belts are to be occupied while vehicle is in motion.

#### Lap-Shoulder Belts

**Fastening:** Hold the belt just behind the tongue using the hand nearest to the door. Next, bring the belt across the body and slide the tongue into the buckle until the latch engages.

**Unfastening:** Press the release button in the buckle. Hold onto the tongue when you release it from the buckle to keep it from retracting too rapidly.

When the lap-shoulder belt is in use, the lap portion must ride across the strong hip area and the shoulder portion must ride diagonally over the shoulder blade toward the buckle.

The shoulder belt is designed to lock only during a sudden stop, sudden body movement or a collision. At all other times it will move freely with the occupant.

#### WARNING

Never wear the shoulder belt in any position other than as stated above. Failure to do so could increase the chance or extent of injury in a collision.

#### Seat Belt Care and Cleaning

- Be careful not to damage the belt webbing and hardware. Take care not to pinch them in the seat or doors.
- Inspect the belts and hardware periodically. Check for cuts, frays, and loose parts. Damaged parts should be replaced. Do not remove or modify the belt system.
- Keep belts clean and dry. If the belts need cleaning, use only a mild soap and water so-

lution. Do not use hot water. Do not use abrasive cleaners or bleach. These products may weaken or damage the belts.

- Replace any belt assembly that was used during a severe impact. Replace the complete assembly even if damage is not apparent.

**CHILD RESTRAINTS**

All 50 of the United States and the District of Columbia now require the use of the child/infant restraint systems for children in vehicles.

A properly installed and secured child restraint system can help reduce the chance or severity of personal injury to a child in an accident or during a sudden maneuver. Children may be injured in an accident if they are not seated in a child restraint which is not properly secured.

A child restraint system is designed to be secured in a vehicle seat by a lap belt or the lap belt portion of a lap-shoulder belt. According to accident statistics, children are also safer when properly restrained in rear seating positions than in front seating positions.

When purchasing a child restraint system:

1. Look for the label certifying that it meets all applicable U.S. Federal Motor Vehicle Safety Standards (FMVSS) or, in Canada, requirements of the Children's Car Seats and Harnesses Regulations (CCSHR).
2. Make sure that it will attach to your vehicle and restrain your child securely and conveniently so that you are able to install it correctly each time it is used.
3. Be certain that it is appropriate for the child's height, weight and development. The instructions and/or the regulation label attached to the restraint typically provides this information.
4. Review the instructions for installation and use of the restraint. Be sure that you understand them fully and can install the restraint properly and safely in your vehicle.

**MIRRORS**

Always adjust mirrors for maximum rear visibility before driving off. Make sure the seat is adjusted for proper vehicle control and that you are sitting back squarely into the seat.

Tilt the surface of the mirror gently up or down, left or right, to obtain the best rear view.

**INSTRUMENT PANEL GAUGES AND CONTROLS**

The illustrations on the following page showing switches and features provided by Winnebago.

See your chassis owner's manual for detailed information on the instrument gauges, steering column controls, brakes, and other chassis original equipment.



## INSTRUMENT PANEL (Ford Chassis)

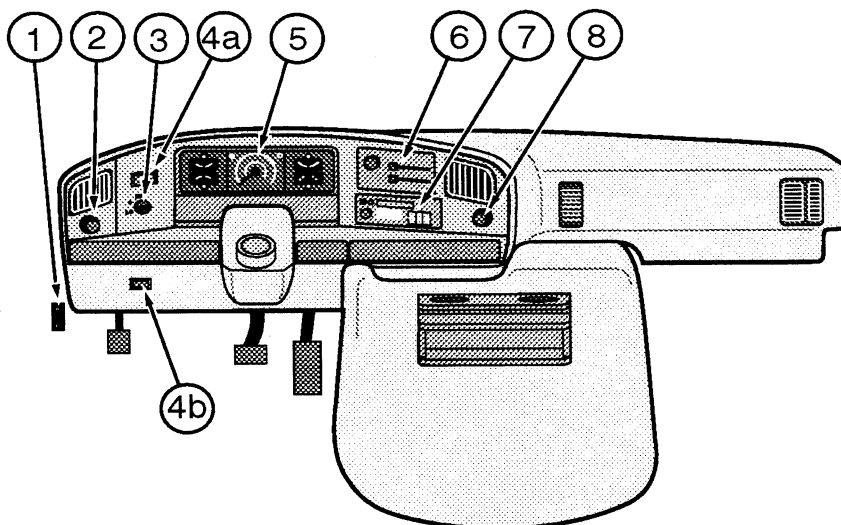

- |  |                                  |
|--|----------------------------------|
| 1. Hood Release Knob                   | 5. Instrument Cluster            |
| 2. Headlight Switch                    | 6. Automotive Heater/AC Controls |
| 3. Rear Auto Heater Switch             | 7. Radio/Cassette Player**       |
| 4a. Aux. Start Switch (Gas Chassis)    | 8. Cigarette Lighter/12V Jack    |
| 4b. Aux. Start Switch (Diesel Chassis) |                                  |

\*\*See manufacturer's operating information.

## SECTION 3 IN CASE OF DRIVING EMERGENCY

# Winnie Winnie

*ty of loose wheels after correct mounting torque is applied.*

*NOTE: Know and obey all state and local towing regulations. Tow at reduced speed.*

### WHEEL NUTS

To properly seat the wheel nuts and to eliminate the possibility of the wheel nuts becoming loosened while driving, they should be tightened at frequent intervals to the torque specified in your vehicle chassis manual. This is especially important during the first 100, 1,000 and 6,000 miles of operation after replacement of a wheel or wheel nuts.

#### WARNING

The operator is advised to obtain road service whenever possible and attempt tire changing under emergency conditions only and with close adherence to instructions. If it becomes necessary to change a wheel, that wheel should be checked after being properly torqued and inspected by qualified service personnel, at 100 miles and every oil change thereafter.

Upon satisfactory completion of emergency tire change, it is highly recommended that the wheel nuts be properly torqued and inspected by qualified service personnel as soon as possible.

### RECOVERY TOWING

See chassis operating guide for proper recovery towing procedures.

Winnebago Industries does not assume responsibility for damage incurred while towing this vehicle.

#### WARNING

Stay out from beneath the motor home while it is suspended by the towing assembly unless the vehicle is adequately supported by safety stands. Do not allow passengers to occupy a towed vehicle.

### JUMP STARTING

#### WARNING

Automotive batteries produce caustic acid, explosive gases, and electrical current which may cause burns. It is important that the instructions below are followed **exactly**, or personal injury (particularly to eyes) or property damage may result due to battery explosion, battery acid, or electrical (short circuit) burns.

- NEVER smoke near the battery or expose it to open flame or electrical sparks.
- Wear eye protection or shield your eyes while working near battery, in case an explosion does occur. NEVER lean over a battery.
- Do not allow battery fluid to contact eyes, skin, clothing, or painted surfaces. Immediately flush any contacted area with water. If eyes are affected, seek medical help after flushing.
- Remove all metal jewelry to lessen the risk of a short circuit occurring.

### CONNECTING JUMPER CABLES

1. Make sure that the other vehicle has a 12-volt battery and negative ground compatible with your vehicle's electrical system.
2. Position the vehicle with the good battery so that the jumper cables will reach, but **do not allow the vehicles to touch**.
3. Turn off all electrical accessories, motors, and lights except those needed for safety or to light up the work area. Place automatic transmission in P (Park). Be sure parking brakes are engaged in both vehicles.
4. If the weak battery has filler caps, make sure the electrolyte is at proper level. Add distilled water if fluid is low. If electrolyte is

not visible or appears to be frozen - **do not attempt jump starting!** A battery may rupture or explode if the electrolyte is frozen or not filled to the proper level.

5. Connect one end of the positive "+" (red) jumper cable to the positive "+" terminal of the weak battery. Connect the other end to the positive "+" terminal of the charged battery.
6. Connect one end of the negative "-" (black) jumper cable to the negative "-" terminal of the charged battery.
7. Finally, connect the remaining end of the negative "-" (black) cable to a solid, metal grounded location on the engine of the vehicle with the weak battery, at a point at least 18 inches from the battery. Do not connect to any moving parts. **THE MAIN SAFETY PRECAUTION IS TO MAKE THE FINAL GROUND CONNECTION ON THE ENGINE AT A SAFE DISTANCE FROM THE BATTERY. THIS HELPS TO REDUCE THE CHANCE OF EXPLOSION DUE TO SPARKS.**
8. Start the engine of the vehicle with the charged battery, and allow it to run for a few minutes at moderate r.p.m. Then start the engine of the vehicle with the discharged battery.
9. Reverse the above sequence **EXACTLY** when removing the jumper cables. Start by removing the cable from the ground location on the engine first, then continue in reverse sequence.

### WARNING

Do not attempt to push-start this vehicle. Damage to the transmission or other parts of the vehicle could occur.

## CONNECTING A BATTERY CHARGER

To connect a battery charger, first make sure the engine is switched off. Disconnect the negative lead from the battery. Never disconnect the battery while the engine is running or alternator damage could result.

Connect the positive "+" (red) lead of the charger to the positive "+" terminal on the battery. Next, connect the negative "-" (black) lead of the charger to a suitable ground. Finally, plug in or switch on the charger.

To disconnect the charger after charging, unplug the charger from the electrical outlets, remove the charger leads from the vehicle, and reconnect the vehicle leads to the battery.

## ENGINE OVERHEAT

If you see or hear steam escaping from the radiator or the engine compartment or have any other reason to suspect an extreme engine overheating condition, pull the vehicle over to the roadside as soon as it is safe to do so, stop the engine and get out of the vehicle.

### WARNING

Operating a vehicle under a severe overheating condition can result in damage to the vehicle and may result in personal injury.

An engine will overheat if the coolant is low or there is a loss of coolant because of one or more of the following:

- a leak in the cooling system
- a hose failure
- a drive belt breaking
- water pump failure

Also, be aware of the following situations, which can cause temporary engine overheating:

- climbing a long hill on a hot day
- idling while stopped in traffic for long periods of time
- towing a trailer or automobile
- stopping after a period of high speed driving

If the TEMP indicator on the instrument panel shows a rise in engine coolant temperature while driving, take the following steps to attempt to lower the overheating condition:

- If you are using the automotive air conditioner, turn it off.
- If you are stopped in traffic, shift the transmission into P (Park), and engage parking brake.

## SECTION 3

### IN CASE OF DRIVING EMERGENCY

---

Minnie Winnie

If the temperature does not drop within a minute or two:

- Pull the vehicle over to the roadside as soon as it is safe to do so.
- Place the transmission in P (Park) and press the accelerator to increase engine speed (r.p.m.'s) to twice that of normal idle speed, and hold it there for approximately two or three minutes.
- If engine temperature does not go down, turn the engine off and wait until the engine has cooled before attempting to open the hood.

When no trace of escaping steam is heard or seen, open the hood to check for the cause of the overheat. Check hose connections and tighten if necessary. Make sure there are no broken belts, pulleys or hoses before adding any coolant to the radiator.

For further information in case of overheating, consult your chassis operating guide.

### TRAVELING WITH YOUR MOTORHOME

(See also SAFETY PRECAUTIONS, Section 1 of this manual.)

#### LOADING THE VEHICLE

When loading the vehicle, distribute the cargo load equally so that you do not exceed either the Front or Rear Gross Axle Weight Rating (GAWR) or the Gross Vehicle Weight Rating (GVWR). The Gross Axle Weight Rating (GAWR) means the weight value specified by the chassis manufacturer as the load carrying capacity of a single axle system as measured at the tire-to-ground interfaces. This is the total weight a given axle is capable of carrying. Each axle has its own rating.

Also distribute cargo side-to-side so the weight on each tire or dual set does not exceed one half of the GAWR for either axle.

For example, if the Front GAWR is 6,000 lbs., there should be no more than 3,000 lbs. on each tire. (If the left side weighs 3,100 lbs. and the right side weighs 2,700 lbs., at least 100 lbs. of the load should be shifted from the left side to the right side.)

Have your vehicle weighed to determine the proper load distribution for your vehicle. The GVWR is listed on the Vehicle Certification Label. (See page 0-3.)

The total combined weight allowed for the vehicle, including trailer towing load weight, is known as the Gross Combined Weight Rating (GCWR). If trailer towing is not recommended, the GCWR will equal the GVWR.

*NOTE: See the Ford Recreation Vehicle and Towing Guide for maximum towing capacities and GCWRs. These guides are available from your local Ford dealer.*

Your cargo capacity will vary according to the options equipped on your vehicle, and your additional equipment and components not supplied with the vehicle. Do not exceed any of the recommended weight ratings.

*NOTE: We recommend that you dump all hold-*

*ing tanks before traveling to avoid carrying unnecessary weight.*

#### CAUTION

The weight of the loaded vehicle (including options, attachments, passengers, water, fuel, luggage and all other cargo) must not exceed the GVWR or GAWR of either axle.

#### FRONT AXLE TIRE ALIGNMENT

We recommend that you have the front suspension and steering alignment checked and adjusted after you have fully loaded the vehicle according to your needs. Thereafter, have alignment inspected periodically to maintain vehicle steering performance and prevent uneven tire wear.

#### WEIGHING YOUR LOADED VEHICLE

To check the weight of your fully loaded coach, locate a commercial weighing scale that is capable of weighing large trucks.

Drive the entire coach onto the scale. This weight should not exceed the Gross Vehicle Weight Rating (GVWR) specified on the Vehicle Certification Label near the driver seat. (See sample on page 0-3).

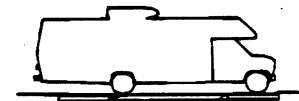

GVWR  
(Both Axles)

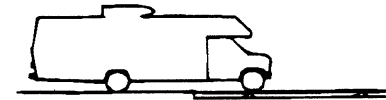

Front GAWR  
(Front Axle Only)

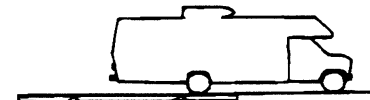

Rear GAWR  
(Rear Axle Only)

Weighing Your Motor Home

## SECTION 4

# TRAVELING WITH YOUR MOTOR HOME



To determine the weight on either the front or rear axle, drive that axle only onto the scale. Neither axle weight should exceed the corresponding maximum axle weight rating specified on the certification label.

### MAXIMUM OCCUPANCY

The following label is placed in a visible location in the driver compartment.

**BELTED SEATING POSITIONS MAY EXCEED SLEEPING CAPACITY OF THIS VEHICLE. SEE OWNERS MANUAL FOR OCCUPANCY AND WEIGHT RESTRICTIONS.**

The number of belted seating positions in your motor home may exceed the number of people used to determine maximum coach occupancy, called the Net Carrying Capacity (NCC) in the U.S. or Cargo Carrying Capacity (CCC) in Canada.

To calculate the NCC or CCC, Winnebago uses vehicle sleeping capacity, however your coach may be equipped with more belted seating positions than sleeping positions to give passengers a choice of seating arrangements. You may use all of the belted seated positions providing you stay within your vehicle's GVWR listed on the Vehicle Certification Label (see page 0-3). However you use or load your vehicle, it is your responsibility to keep the weight within its stated gross vehicle weight rating.

### ROOF LOADING

The roof on most models is capable of carrying some lightweight articles while the vehicle is in motion. A roof-mounted luggage carrier designed for this purpose is available from your dealer. However, roof load while the vehicle is in motion is not to exceed 10 pounds per square foot or a maximum of 100 pounds.

When the vehicle is stationary, a cargo load of 100 pounds plus the weight of a 225 pound person to load the cargo or to conduct inspection and maintenance is permissible.

Weight added to both the roof and the trailer hitch contribute to the gross vehicle weight,

which must not exceed the vehicle's GVWR.

### TRAILER TOWING

The factory installed towing hitch on this coach is capable of pulling 3,500 lbs. (max.) and carrying 350 lbs. (max.) on the hitch ball. However, your coach's towing and hitch ball capacity may be less due to the coach's loaded weight and/or the towed vehicle's weight and hitch ball weight. The combined weight of the coach and the towed vehicle should not exceed the coach's Gross Combined Weight Rating (GCWR). Also, the combined weight of the coach and the towed vehicle's hitch ball weight should not exceed the coach's Gross Vehicle Weight Rating (GVWR) or its rear Gross Axle Weight Rating (GAWR) listed on the Vehicle Certification Label.

Because of individual vehicle use and loading habits, we recommend weighing the vehicle while fully loaded to avoid exceeding any of the listed Gross Weight Ratings. See "Vehicle Certification Label" on page 0-3 for information on gross weight ratings.

Towing will affect vehicle handling, durability and fuel economy. Exceeding any of the listed Gross Weight Ratings will result in unacceptable overall vehicle performance. Maximum safety and satisfaction when towing depends on proper use of correct equipment. A hitch bar of appropriate steel and size should be selected to mate with the Winnebago towing receptor.

Installation of a proper trailer brake system is recommended. Check state regulations on trailer weight and trailer brake requirements to be sure you select the right equipment before towing.

*NOTE: If you tow a car or trailer that weighs over 1,000 lbs., it must be equipped with automatically activated brakes. See the Ford Recreation Vehicle and Trailer Towing Guide for maximum towing capacities and GCWRs. These guidelines are available from your local or Ford dealers.*

Before descending a steep or long grade when towing a trailer, reduce speed and shift into a lower gear to control vehicle speed. Avoid prolonged or frequent application of brakes which could cause overheating and brake failure.

### WARNING

For safety towing and vehicle handling, maintain proper trailer weight distribution.

The total weight of the motor home and the vehicle towed must not exceed the Gross Combined Vehicle Weight rating. Contact the chassis manufacturer to obtain the Gross Combined Vehicle Weight rating for your chassis.

### CAUTION

Exceeding any of the recommended gross vehicle weight ratings may result in vehicle damage.

Do not install a frame equalizing type hitch on your vehicle.

See also - Trailer wiring connector, page 6-8.

### PRE-TRAVEL CHECK LIST

Before starting the engine to leave on a trip, be sure your motor home has been properly prepared and maintained. This will ensure an enjoyable trip and help avoid delays. Use this checklist as a guide.

- Fluid Levels - Check and fill if necessary:
  - engine oil
  - transmission
  - power steering
  - radiator
  - brake
  - battery
  - windshield washer
- Wheel Lug Nuts - Check for tightness
- Tires - Check for proper cold inflation pressures as specified on the Vehicle Certification Label.
- Drive Belts - Check for proper condition and tension (not cracked, frayed, or loose, etc.)
- 110-Volt Generator (Optional) - Check oil level in generator engine.

### WARNING

Never check oil level in generator while engine is operating.

- Fire Extinguisher - Make sure it is fully charged and secured in mounting bracket.
- Lights - Make sure all exterior lights operate.
- Sewer and Water Supply Hose - Unhook and store.
- TV Antenna - Make certain the TV antenna is lowered and seated in its support cradle.
- Loose Items Inside the Motor Home - Store or secure items.
- Pilot Lights - Make sure all pilots are off.
- Fuel Tanks - Check level.
- Water Tank - Fill with fresh water.
- Exterior Door and Step - Make sure doors are closed, locked and step retracted.
- Seats - Adjusted for comfortable position and locked in place.
- Mirrors - Adjust for maximum visibility from driver's seat.

### EQUIPPING FOR TRAVEL

When beginning a trip, several items should be taken in addition to the basic clothes, food and recreational items. A checklist is provided for your convenience. Remember, it is important to distribute weight and store all heavy items near the floor.

### EMERGENCY EQUIPMENT CHECKLIST

Flashlight  
 First Aid Kit  
 Road Emergency Flares  
 Tool Box with Assortment of Hand Tools  
 Plastic Bucket  
 Tow Chain or Rope  
 Wheel Blocks or Extra Jacks for leveling  
 Water Hose  
 100-150 Feet of 3-Wire Electrical Cord with at least 30 AMP Capacity  
 Fire Extinguisher  
 Hydraulic Jack and Lug Wrench  
 Spare Tire

**QUICK LOADING CHECKLIST****BEDDING**

- Sleeping Bags
- Sheets
- Pillow Cases and Pillows
- Mattress Pads
- Extra Blankets
- Laundry Bags

**COOKING**

- Can Opener
- Bottle Opener
- Aluminum Foil
- Matches
- Plastic Bags
- Coffee Pot
- Storage Dishes

**CLEANING**

- Scouring Pads
- Cleanser
- Glass Cleaner
- Dish Soap
- Sponge
- Laundry Soap
- Cleaning Rags or Paper Towels
- Garbage Bags

**BATHROOM**

- Bath/Hand Soap
- Bath Towels that can double as Beach Towels
- Toiletry Kits
- Toothbrushes and Toothpaste
- Shaver/Razors
- Toilet Tissue (RV)

**BABY NEEDS**

- Car Seat (Child Restraint)
- Portable Crib
- Play Pen

**PERSONAL**

- Credit Card(s)
- Traveler's Checks
- Money
- Driver's License
- Proof of Citizenship (for Canadian or Mexican crossing)
- Sunglasses

**PET NEEDS**

- Food
- Leash
- Water and Food Dishes
- Proof of Rabies Shot

**MISCELLANEOUS**

- String
- Clothesline
- Insect Repellent
- Masking Tape

**TRAVEL TIPS**

As you travel around the country in your motor home, you will pick up useful advice from other motor home owners.

A number of suggestions can also be obtained by reading articles and regular columns in outdoor and camping magazines. Some magazines and publishing companies print an annual park and campground directory. These can be found at your local news stand or RV supply dealer. Here are a few travel tips to begin with.

1. Always check for sufficient clearance. Know the height and width of your unit.
2. Always fill the fresh water tank at an approved potable water filling facility or a known purified drinking water source. Taste the water before filling the water tank in an unfamiliar location. The water in some areas may contain an undesirable taste. Do not use a new hose to fill the water tank. It can leave a distinct rubber or vinyl taste.
3. Showers can take a lot of water. Conserve water by taking a "Sea Shower". This is done by wetting down, turning off the water, soaping thoroughly and then rinsing.
4. Dump sewage only at approved dumping stations.
5. Store liquids in plastic containers with tight fitting caps to prevent spills.
6. Keep an eye on the water and holding tank levels. It is a good idea to dump the holding tank at least every two days.
7. When traveling with children, it is helpful to plan their wardrobe for a week. Place each days clothing in a plastic bag and label the bag with the child's name and day of the week for use.



8. Use sleeping bags whenever possible. They save laundry and take up less storage space than bedding.
9. Make sure all compartment doors have been closed and the door step has been stowed in the correct position before moving the vehicle.
10. Before traveling, make sure the refrigerator door has been secured. Use care when opening the refrigerator door after the vehicle has been stopped. Any articles that have shifted may fall out when the door is opened.
11. During peak tourist season and holidays, it is best to phone ahead and make reservations at the park where you plan to stop.
12. Some states or cities will not permit vehicles with LP gas containers to pass through highway tunnels. If your route includes a tunnel, check with the highway patrol or department of highways to avoid inconvenience.
13. Do not leave food or odor-causing material in your vehicle for extensive periods of time. Always allow damp clothing, swimwear, hunting gear, etc., to dry before stowing.
14. Become familiar with the fire extinguisher and make sure it is always fully charged. Remove and replace it and read instructions so you know the correct operating procedure before an emergency happens.
15. Make a list of all groceries, fresh meats, vegetables, newspapers, etc., that you may need and try to pick them up during your last fuel stop of the day. This will prevent leaving a good parking spot once you have arrived at your destination.
16. When you sit over the front wheels while driving, as in a motor home, you have a tendency to crowd the middle of the road. Check the side view mirror frequently to observe how close you are driving to the center line.

### SEVERE WEATHER INFORMATION

One of the more serious conditions affecting the motor home traveler and camper is that of the weather. Whether you travel the high mountain terrain, the lower deserts and flatland or the plains of the midwest, the weather is always with you and subject to change, sometimes with little or no warning. However, adequate warnings are normally broadcast over local radio and TV stations.

Motor home travelers and campers often seek secluded areas for weekend recreation or extended summer vacations. Many recreational areas are vulnerable to severe weather situations, especially flash flooding conditions. A few simple precautions may help lessen the hazards of flash flooding or reduce your immediate involvement.

*NOTE: We recommend that all motor home occupants become familiar with these safety precautions, and be alert to change in weather.*

- Be alert, because thunderstorms can form at any time, in any month of the year. Thunderstorms can produce large amounts of rain over a small area in a short time, which may result in a flash flood. Listen frequently to weather reports on the radio for weather and flood conditions.
- When camping near a stream, leave plenty of sloping bank between you and the stream.
- Avoid deep canyons and dry washes during stormy or threatening weather. Be aware of alternate exits.
- If heavy rain occurs, move to high ground immediately (at least 30-40 feet above the canyon floor or bottom of dry wash).
- During a flash flood, if you cannot move your vehicle, abandon it. Do not attempt to return to your vehicle before the water has receded.
- Do not attempt to wade to your vehicle if the water is above your knees - fast moving water exerts an enormous amount of pressure, making it impossible to remain standing or walking.
- Do not try to drive through flooded areas.
- Follow instructions of local authorities. Leave immediately when advised to do so. Many lives have been lost because people did not heed warnings.
- Have on hand survival supplies for several days, including food, water, first aid equipment and necessary medications. In desert ar-

## SECTION 4

# TRAVELING WITH YOUR MOTOR HOME



eas during hot weather allow 3-4 gallons of drinking water per person, per day.

- Before you leave home, inform someone of your destination and when you expect to return. Authorities at your destination should be notified immediately if you do not arrive on time.

### REMEMBER THESE TERMS:

**WATCH:** Severe weather may develop in the specified area. Be alert and prepare for possibility of an emergency.

**WARNING:** Severe weather is occurring or is imminent in certain areas. Move to a safe location immediately.

We highly recommend that you obtain a weather radio. These radios offer up-to-date weather reports. The latest information and forecasts are broadcast by local National Weather Service offices in recorded messages that last from three to five minutes. These messages are replayed continually 24 hours a day. The recorded messages are revised every three to four hours, or more frequently when appropriate.

When severe weather threatens, forecasters at the local National Weather Service office interrupt the broadcasts with storm warnings, either recorded or “live” as the situation demands.

The frequencies used for NOAA Weather Radio (National Oceanic and Atmospheric Administration) nationwide are 162.40, 162.475 or 162.55 megahertz.

### NIGHTTIME DRIVING

- Make sure all running lights and signal lights are clean and in working order. Have your headlights periodically checked and adjusted.
- Use care when passing other vehicles. Your motor home is a longer vehicle than a car, and you may have a more difficult time knowing when to pull back into your lane. If possible, have another person in the coach help you watch while maneuvering your motor home in traffic.

### MOUNTAIN DRIVING

Special techniques must be used when driving in mountainous or hilly country.

#### Climbing A Hill

The transmission will automatically down-shift as needed to climb most hills. If the hill is long or very steep, however, you may need to manually shift to a lower gear to keep the transmission from repeatedly upshifting and downshifting. Select the lowest adequate gear range for the duration of the incline. See your chassis operating guide for more information.

#### CAUTION

Observe the engine temperature gauge more frequently than normal. If overheating occurs, pull off to the side of the road and allow the engine to thoroughly cool before refilling the radiator and restarting the engine.

#### Descending A Hill

When going down a long grade, you may need to manually shift to a lower gear, rather than keeping your foot on the brake pedal. A lower gear will allow the engine to provide a degree of braking action. Holding your foot on the brake pedal for an extended period may cause brakes to overheat, causing you to lose control of the vehicle. See your chassis operating guide for more information.

### CAMPSITE SET-UP

Try to pick as level a spot as possible on which to park your motor home.

Leveling the motor home is very important, not only for your comfort, but for plumbing and appliances as well. Some refrigerators are extremely sensitive to being unlevel. The ammonia vapor cooling system used in most RV refrigerators can “lock up” and damage the refrigerator if it is not level. This is both inconvenient and costly. Also, water and holding tank level indicators may give false readings because water level is greater at one side of the tank than the other.

### Blocking

A motor home can be leveled using several methods, including sophisticated electronic-hydraulic systems. The most common and inexpensive method, however, is "blocking."

This is done by stacking various lengths of planking (blocks) into a ramp-like formation in a low spot to drive the tire onto, thus leveling the coach as shown.

Wedge a pair of wheel chocks or similar devices in front and back of a tire that is on the ground as shown to keep the coach from rolling forward or backward off the leveling blocks.

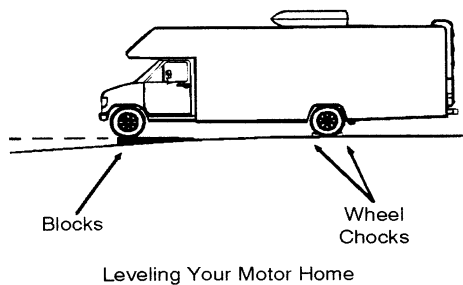

When placing blocks beneath a set of rear dual wheels, be sure the blocks support both tires so that the load weight is not resting on one tire, which could damage that tire.

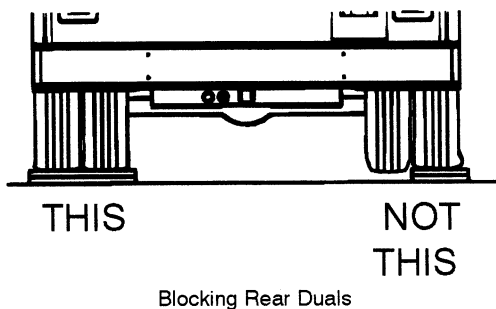

To provide extra firmness, you can place inexpensive mechanical jacks, jack stands or hydraulic "bottle" jacks under the frame to keep the coach from moving on the suspension springs while walking around inside the coach. These devices are not intended to lift the coach; only to hold it rigid and steady.

**NOTE:** We do not recommend lifting any of the wheels off the ground for leveling. This could allow the coach to roll off the jacks, possibly resulting in damage to the vehicle.

### EFFECTS OF PROLONGED OCCUPANCY

Your motor home was designed primarily for recreational use and short term occupancy. If you expect to occupy your coach for an extended period, be prepared to deal with condensation and humid conditions that may be encountered.

### HUMIDITY AND CONDENSATION

Moisture condensing on the inside of windows is a visible indication that there is too much humidity inside the coach. Excessive moisture can cause water stains or mildew which can damage interior items such as upholstery and cabinets.

When you recognize the signs of excessive moisture and condensation in your coach, you should take immediate action to minimize their affects.

You can help reduce excessive moisture inside the motor home by taking the following steps:

**Ventilate with outside air:** Partially open one or more windows and a roof vent to circulate outside air through the coach. In cold weather, this ventilation may increase use of the furnace, but it will greatly reduce the condensation inside the coach.

**Minimize moisture released inside the coach:** Run the range hood fan while cooking, and open a bath vent while bathing or showering to carry water vapor out of the coach. Avoid making steam from boiling water excessively or letting hot water run. Avoid bringing extra moisture into the coach by way of soaked clothing or snow on shoes. Do not hang-dry wet overcoats or clothing inside the coach.

**NOTE:** Your coach is not designed or intended to be used as permanent housing. Using this product for long term occupancy or permanent housing may lead to premature deterioration of structure, interior finishes, fabrics, carpeting and drapes. Damage or deterioration due to long term occupancy may not be considered normal and, under the terms of the warranty, may constitute misuse, abuse, or neglect, and may therefore reduce your warranty protection.



(See also Safety Precautions, Section 1 of this manual.)

### LP GAS SUPPLY

The LP gas system supplies fuel for the range, water heater, furnace and refrigerator (while in gas mode). When used and handled properly, this system is safe and economical and provides modern living conveniences wherever you travel.

### SAFE USE OF THE LP GAS SYSTEM

The LP system is designed and built with strict adherence to both federal and recreational vehicle industry requirements for mobile LP gas equipment.

For your safety, there are many safety devices and backup systems installed, such as tank fill overflow valves, an interior LP gas detector/ alarm, and an interior carbon monoxide (CO) detector/alarm.

LP gas also contains an odor additive that you can smell if LP is present in the air.

Listed below are a few precautions to observe that will help you to use the LP gas system safely.

- Exercise caution at all times. Be familiar with the distinctive odor of LP gas. If a leak is suspected, turn off the supply valve immediately. Have the LP gas system checked by your dealer or a qualified LP gas service center.
- Do not tamper with the LP gas piping system, pressure regulator or gas appliances. Service and maintenance of LP gas system components should be performed only by your dealer or a qualified LP gas service center.
- Never attempt to connect natural gas to the LP gas system.
- Have the entire LP gas system inspected for possible leaks and missing or damaged parts at each tank filling. Also inspect before and after each trip, and any time trouble is suspected.
- Turn the LP supply valve off when not using the LP gas system.
- Never use a wrench to tighten the tank supply valve. It is designed to close leak-tight by hand. If a wrench is required to completely close the valve, it is defective and must be replaced.
- Never allow the tank to be filled above the 80 percent level indicated by the flow of liquid gas out of the overflow valve or by the automatic stop-fill device.
- Be sure appliance and outside vents are open and free from obstruction when using the LP gas system.
- Never attach a lock or any device requiring a key to the LP tank compartment door. According to standards set for recreation vehicles, the LP supply valve must be readily accessible in an emergency.
- Exercise caution when drilling holes or attaching objects to the walls. Gas lines and electrical wiring could be seriously damaged and present an extreme safety hazard.

### HOW LP GAS WORKS

LP (Liquified Petroleum) gas is a true gas compressed into liquid form for easy transportation and storage. LP gas is available in two types - propane and butane. It is also called tank gas, bottle gas, or simply LP.

LP is used by appliances in vapor form only, but is stored in the tank as a liquid under very high pressure. As the liquid gas is released, it reverts back to a vapor and expands to many times its compressed volume.

### SELECTING FUEL TYPES

Butane burns hotter than propane, but will not develop a usable gas vapor at temperatures lower than 32° F. Propane, on the other hand, does not burn as hot but will convert to usable gas at temperatures down to -44° F. For this reason, propane is popular in cold climates, while butane and propane/butane mixtures are used most widely in milder climates.

*NOTE: Most LP dealers normally handle only the type of LP gas commonly used in their climate and area. If you anticipate filling your tank in one of the warmer states prior to traveling to a colder area, it is advisable to request propane only. Otherwise your LP system may fail to operate if the temperature drops below 32° F.*

## LP GAS OUTPUT

Each gallon of liquid LP gas contains approximately 92,000 BTU's of heat energy; or about 36.2 cubic feet of dry gas for cooking, heating, water heating and refrigeration.

To find out how long a gallon of LP gas will last, you should determine the total BTU **input** on all your LP gas appliances in use. Let's say you have a furnace that has a 10,000 BTU **input** per hour of operation. A gallon of LP gas would last 9.2 hours of continuous operation (92,000 BTU's ÷ by 10,000 BTU's = 9.2). To estimate how long a gallon of LP gas lasts, try to determine what your total daily BTU input is, then divide into 92,000 to arrive at an approximate daily LP gas consumption.

## LP TANK SYSTEM

The storage reservoir for the LP gas system is a horizontally mounted tank which is permanently attached to the vehicle frame. The tank is accessible only from the outside of the vehicle. The tank supply valve is located near the top center of the tank, next to the regulator. Before opening the supply valve, check to be sure all controls for gas appliances are in the "Off" or "Pilot Off" position. If this step is not performed, LP gas could accumulate inside the motor home creating a fire or explosion hazard.

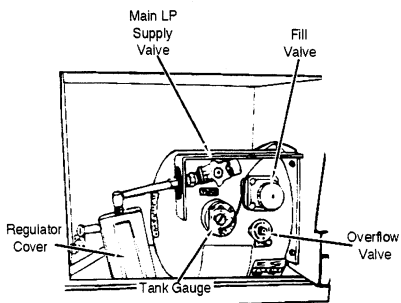

## LP Gas Tank Capacity

All Models ..... 14 gal./60 lbs.

\*Tank size is the approximate usable volume, which is 80% of total tank volume. LP gas tanks are sometimes listed in pounds rather than gallons. For reference, a gallon of liquid propane gas weighs 4.24 pounds and a gallon of liquid butane gas weighs 4.84 pounds.

## REFILLING LP TANK

There are many LP gas refueling stations located throughout the country. These stations are listed in the telephone directory Yellow Pages under "Gas - Liquefied Petroleum - Bottled and Bulk."

Since the LP tank is permanently mounted to the frame, the motor home must be taken to an LP dealership for filling. Do not attempt to remove the LP tank from the vehicle. The tank is equipped with a fill adapter with both internal and external threads which allows easy filling with any LP filling equipment. The tank is full when liquid LP gas appears at the overflow valve.

*NOTE: The LP tank is equipped with an automatic 80% stop-fill device.*

## AIR IN THE LP GAS TANK

If your LP gas appliances do not stay lit or require frequent adjustment, even though you know the LP tank contains sufficient fuel, the problem may be air in the LP gas tank. Air in the tank mixes with the LP gas vapors causing them to burn poorly. This condition could linger for weeks if the air is not purged from the tank. Most LP gas dealers have equipment for purging air from LP gas tanks and will purge before refilling the tank.

## TRAVEL WITH LP GAS

It is illegal for vehicles equipped with LP tanks to travel on certain roadways or through certain tunnels in the U.S. To avoid inconvenience, check state regulations concerning flammable gas transportation.

### WARNING

**DO NOT FILL CONTAINER TO MORE THAN 80 PERCENT OF CAPACITY.** Make sure the motor home is level when filling. It is possible to accidentally overfill the tank if the vehicle is unlevel, with the fill valve on the uphill side. Overfilling the LP gas tank can result in uncontrolled gas flow, which can cause fire or explosion. A properly filled container will contain approximately 80 percent of its volume as liquid LP gas.

**All pilot lights must be extinguished** and supply valve closed before refilling LP gas tanks or vehicle fuel tanks.

**Do not smoke or expose an open flame** while near an LP refueling area. LP gas is heavier-than-air and extremely flammable.

**Never use an open flame** to test for LP gas leaks.

Replace all protective covers and caps on LP system before filling.

**Never fill the LP tank with engine or generator running.**

### WARNING

Inspect the pressure regulator vent hole periodically for blockage. If any obstruction is apparent, have the regulator serviced by your dealer or a qualified LP gas service center.

LP gas regulators are installed with the diaphragm vent facing downward. Make sure that the regulator vent always faces downward to minimize vent obstruction which could result in excessive pressure, causing a fire or explosion.

Regulator freeze-ups are caused by the presence of moisture in fuel. This moisture will pass through the cylinder valve and into the regulator where it can freeze. Fuel producers, tank and bottle manufacturers and LP gas dealers take every precaution to reduce moisture, but sometimes only a fraction of an ounce entering the tank can cause problems. To help avoid the possibility of freeze-up, always keep tank control valve closed when not in use, even when tank is empty, to prevent moisture from collecting on the inside.

If regulator freeze-up should occur, you may attempt to thaw the regulator using a light bulb. **DO NOT USE AN OPEN FLAME OR HEAT LAMP.**

## REGULATOR

The pressure regulator is protected from the elements by a plastic cover which should be left in place at all times. Only your dealer or a qualified LP gas service should remove the regulator cover for adjustments.

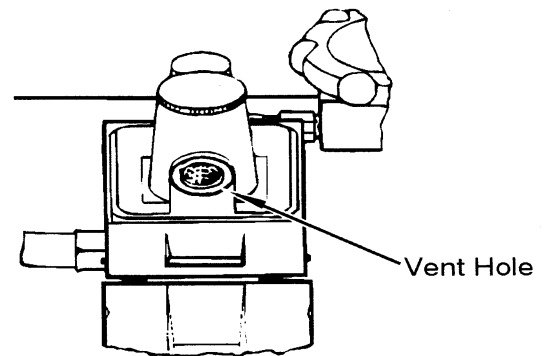

LPG PRESSURE REGULATOR  
(COVER OPEN)

If moisture begins to cause problems, have your LP gas dealer inject a small amount of dry methyl alcohol in your tank (approximately one ounce to 20 pounds or one pint to 100 gallons) to help guard against regulator freeze-ups.

In very cold weather when a large volume of gas is being used for heating, it is possible to experience a loss of gas pressure. At first, this problem may appear to be caused by a regulator freeze-up, but is actually caused by failure of the liquid gas to vaporize as fast as it is needed. As the temperature becomes colder, it is increasingly harder for the liquid LP gas to vaporize. At the same time, the demand for LP to produce heat increases to the point where the system cannot maintain production.

The only solution to this problem is to reduce the consumption of gas where possible. Adjusting the temperature on the gas/electric refrigerator may be a first step. Using less hot water will help as well.

**LP GAS LEAKS**

The following label has been placed in the vehicle near the range area. If you smell gas within the vehicle, quickly and carefully perform the procedures listed.

<b>IF YOU SMELL GAS</b>	
1.	Extinguish any open flames, pilot lights and all smoking materials.
2.	Do not touch electrical switches.
3.	Shut off the gas supply at the tank valve(s) or gas supply connection.
4.	Open doors and other ventilating openings.
5.	Leave the area until odor clears.
6.	Have the gas system checked and leakage source corrected before using again.

**WARNING**  
Never use an open flame to test for gas leaks. When testing for gas line leaks with a soapy water solution. **DO NOT** use a detergent containing ammonia or chlorine. These substances may generate a chemical reaction causing corrosion to gas lines, resulting in dangerous leak conditions.

**WINTER USE OF LP GAS**

Due to vaporization characteristics of LP gas, it is important that the winter camper knows how to most efficiently use the LP system. The vaporization rate of LP gas decreases in a direct relationship to a decrease in temperature. As explained in the "Selecting Fuel Types" section, butane does not vaporize below 32° F, so propane must always be used in cold climates. However, even propane vaporizes at a slower rate as it becomes colder.

The greater the amount of liquid gas in the tank (up to 80% level) the greater the amount of LP gas vapor generated. The following is an example of the number of BTU's available from an 84-pound tank at 0° F at three levels. As you can see, the number of BTU's decreases as the tank is emptied. Nearly twice as many BTU's are available from a full tank than one that is one-fourth full.

<b>BTU's Available at 0° F.</b>	
<u>Tank Level</u>	<u>BTU's</u>
80%	64,000
50%	50,400
20%	33,000

The following LP Gas Vaporization and Temperature Relationship chart typifies the LP gas loss with a decrease in temperature. The percentage figures are the increase or decrease of vapor that would be available at 0°F. These figures apply to any size LP gas tanks.

<u>Temperature</u>	<u>Percentage of BTU's Available at 0° F.</u>
20° F.	200%
10° F.	150%
0° F.	100%
-5° F.	75%
-10° F.	50%
-15° F.	25%
-20° F.	12 1/2%
-44° F.	Propane will not vaporize

**LP GAS ALARM - See page 1-2.**



(See also Safety Precautions, Section 1 of this manual.)

Your motor home is equipped with an electrical system consisting of two separate voltages; a 12-volt DC system and a 110-volt AC system. The 12-volt system consists of two internal power sources, while the 110-volt system is operated from an outside power source or the optional 110-volt generator. All systems operate through a single power converter control center to provide electrical power to the motor home.

### 110-VOLT AC SYSTEM

The 110-volt system operates from an outside 110-volt utility service such as those at campgrounds, or from the optional 110-volt generator. When the power cord is connected to an outside power source, or when the generator is in operation, the power converter automatically changes a portion of the 110-volt current to 12-volt DC current. All equipment in the motor home that is normally powered by the auxiliary battery is then powered through the converter.

In addition, the following equipment is entirely dependent on the 110-volt generator or outside source: roof air conditioner, refrigerator (when placed in 110-volt mode), microwave oven, ice maker, vacuum cleaner and other 110-volt electrical equipment used at convenience outlets.

### EXTERNAL POWER CORD (Shoreline)

The external utility power cord (commonly referred to as a "shoreline") is stored in the utility compartment on the left (driver's) side of the coach.

**WARNING**

**Do not** connect the external power cord to any receptacle **until** you have contacted the owner and/or attendant of the premises to verify proper polarity and grounding.

It is the responsibility of the owner of the electrical receptacle to ensure that the receptacle is properly wired and grounded.

Reverse polarity and improper grounding of the vehicle can cause personal injury or death.

To connect to an external power source, remove the cord from the storage compartment and plug it into a suitable power receptacle.

A small "hatch" provided in the compartment floor allows the door to be closed while the cord is attached to an external source.

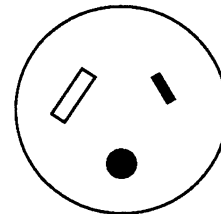

30 Amp Receptacle

The three-prong power cord is designed to ground the electrical system through the receptacle. It is also designed to carry the amperage output of most campground outlets. If the electrical receptacle to be used is designed to mate with the three prongs on the power cord plug, the electrical connection can be expected to carry rated load. (See approximate power consumption table on page 6-5.)

**WARNING**

Do not plug the power cord into an outlet which is not grounded, or adapt the plug to connect to a receptacle for which it is not designed.

Be sure that all three prongs of the supply cord are properly plugged into the receptacle.

Do not connect the power cord to an extension cord.

Do not plug the power cord into the generator receptacle while the generator is already running.

Most campgrounds are equipped with a fuse or circuit breaker at the receptacle. This protects the park's wiring, as well as the power cord on your vehicle, from electrical damage. If electrical power fails, contact the park attendants and have them check the fuse or breaker for your supply receptacle.

After disconnecting the power cord, neatly replace it in the storage compartment.

**POWER CONTROL (Converter)**

The power converter changes 110-volt AC current from the auxiliary generator or the shore-line into 12-volt DC current for use by 12-volt equipment in the motor home.

Certain circuits, however, remain unchanged for use by items which require 110-volt current, such as the air conditioner(s), the refrigerator in AC mode, the microwave oven, etc.

Current drawn from the coach batteries passes through the power center unchanged, although it is routed through a series of protective fuses located on the power panel.

The converter is located in a lower cabinet face in the galley, living area, or beneath a bed. The converter power panel contains the coach electrical system 110-volt circuit breakers and 12-volt fuses.

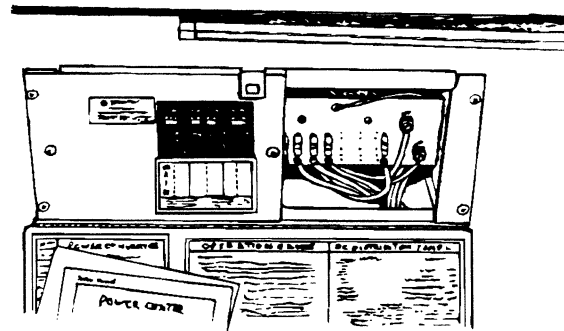

Power Converter

**WARNING**

Do not store anything around or on top of the converter, or in front of the cover. The converter generates heat while operating, and needs unrestricted air flow for proper cooling.

**CHARGING SECTION**

The converter charges coach batteries while 110-volt external power is connected. The converter will automatically "sense" the condition of the RV battery. If it is below "full charge", the Charging Section will start charging the battery.

If the coach batteries have been extremely discharged, they will accept charge at a relatively high amperage rate. If they are only slightly discharged, they will charge at a lower amperage rate. The rate of charge will decrease as the batteries reach "full charge". Active charging will not resume until batteries again fall below "full charge". The converter will not overcharge the batteries. If your storage battery does not charge as described above, it is possible the battery is defective.

**THERMAL BREAKER**

A protective thermal breaker will "break" the 110-volt AC power to the converter section of Power Center if the power converter becomes overheated. This can result from operating above its maximum limit for an extended period of time or by obstruction of ventilation to unit.

*NOTE: Power converter section will automatically route 12-volt lights and motors to battery power in this event.*

The thermal breaker will reset itself after a period of time, and the lights and motors will again resume operation from power converter section. If the breaker trips again shortly after reset, take immediate steps to correct cause of overheating. A portion of RV 12-volt load (lights or motors or both) should be turned off to reduce total load. Also, inspect power converter section to make sure ventilation is not obstructed.

*NOTE: The converter will not change 12-volt DC current to 110-volt AC.*

### 110-VOLT CIRCUIT BREAKERS

The breaker panel protects all 110-volt components in the motor home from either an overload on the circuit or a short in the wiring or component itself. When an overload or short develops, the breaker will open preventing any further flow of electricity and, therefore, damage to the system.

Shut off the equipment (example: roof air conditioner) and allow a brief cooling period. Then reset the breaker by moving the switch to "Off" and back to "On". If the breaker is continually tripped and no overload is evident, have the system checked for a short in the wiring or the appliances.

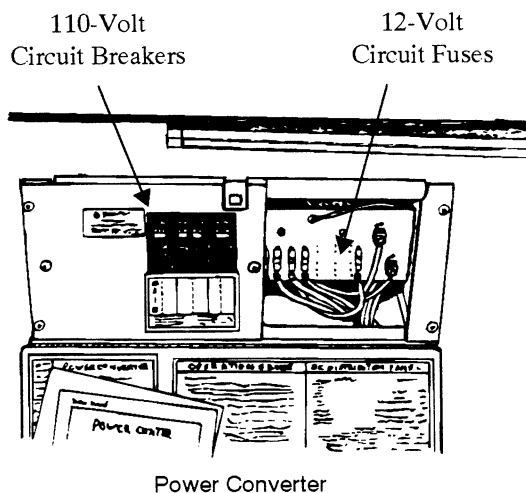

### Further Information

Refer to the converter manufacturer's information provided in your Motor Home Operations Manual binder for additional information about your power converter system.

### 110-VOLT RECEPTACLES (Outlets)

A number of standard AC electrical outlets are provided throughout the coach for connecting small appliances such as televisions, radios, toasters, etc. Outlets are also located on the outside of the coach near the entrance door.

### GROUND FAULT CIRCUIT INTERRUPTER

Exterior, bath and galley outlets are connected to a GFCI (Ground Fault Circuit Interrupter), which is an extremely sensitive circuit breaker that will help to protect against severe electrical shock if a ground fault develops. If such a condition occurs, the GFCI will break the circuit by turning off the power to the protected outlets. Should this occur, unplug all the appliances on that circuit and press the reset button on the GFCI equipped outlet.

If the GFCI keeps tripping, have the electrical system checked and repaired if necessary before using again.

The GFCI outlet is located in the bath, bedroom or dinette area, depending on the floor plan of the vehicle.

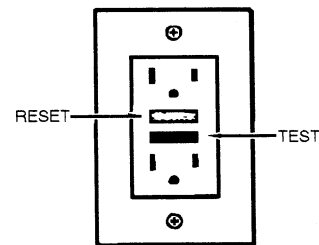

#### WARNING

The GFCI will not completely eliminate electrical shock. Small children and persons with heart conditions or other disabilities which make them especially sensitive to electrical shock may still be injured by a 110-volt receptacles even though protected by a Ground Fault interrupter.

*NOTE: In compliance with CSA electrical codes, the appliance outlet in Canadian equipped coaches is not connected to a GFCI protected circuit.*

## AUXILIARY 110-VOLT GENERATOR

### Optional

Consult the information provided in your Owner Operation Manual binder for instructions on operation, troubleshooting and maintenance.

#### WARNING

Careless handling of the generator and electrical components can be fatal.

Never touch electrical leads or appliances when your hands are wet, or when standing in water or on wet ground.

Do not attempt to repair the generator yourself. Service should be performed by an authorized service center.

Do not plug the power cord into the generator receptacle while the generator is running.

To use the 110-volt generator, plug the power cord into the generator receptacle within the shoreline compartment before starting the generator.

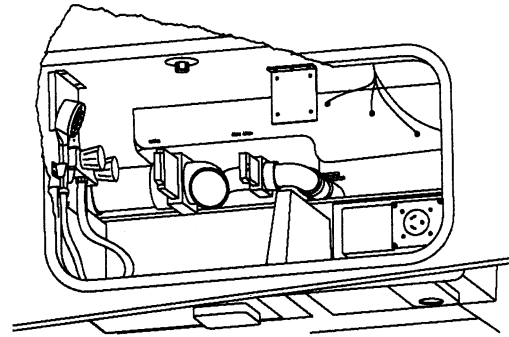
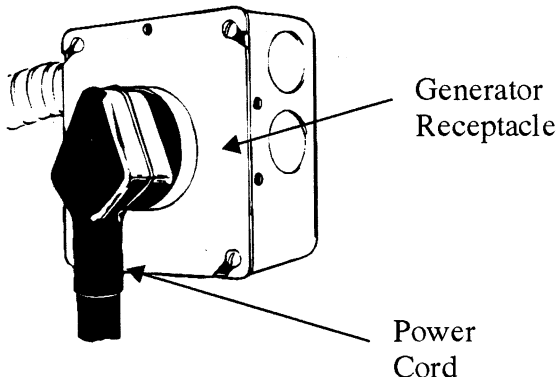

## STARTING AND STOPPING THE GENERATOR

The generator switches are located on the dash and on the range hood. The generator starter circuit does not rely on the automotive battery, so the switch will operate whether the ignition switch is on or off.

This coach may be equipped with one of several models of generators. Consult the generator owner's manual in your Motor Home Operations Manual binder for specific instructions on starting and stopping your generator.

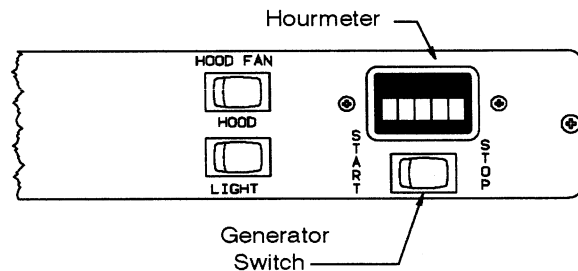

### Basic Generator Operation:

#### Starting:

- See generator manufacturer's operating information for specific instructions.
- Reduce all electrical loads. (Shut off lights, fans, appliances, etc.)
- If the generator has not been run for two weeks or more, you may need to prime the fuel system before attempting to start.
- Press the generator starter switch on and hold until generator engine is running, then release.

- Let the generator engine stabilize and run smoothly before turning appliances or electrical equipment on.
- Refer to the output specifications of your generator in the generator manufacturer's manual.
- Do not overload generator by turning too many items on. See load chart for estimation of typical RV loads.

### Stopping:

- Before shutting generator down, turn off electrical loads and let engine run at no-load for a few minutes to cool down.
- Press the generator switch Off and hold until the generator engine comes to a complete stop.

**CAUTION**

Continuous generator overloading can cause high operating temperatures that can damage the generator windings. Keep the electrical loads within the generator wattage rating.

Approximate Power Requirements of Common Appliances	
Appliance or Tool	Approximate Power Consumption (Watts/Amps)
Vacuum cleaner	200-500W/1.7-4.3A
Coffee Maker	550-700W/4.8-6.1A
Hair dryer	800-1500W/7.0-13.0A
Electric clothes iron	500-1200W/4.3-10.4A
Electric blanket	50-200W/0.4-1.7A
Television	80-100W/0.7A
Electric drill	250-750W/2.2-6.5A
Air conditioner	1400-2000W/13-19A
Converter	300-500W/2.6-4.3A
Microwave Oven	700-1500W/6.0-13.0A

### GENERATOR HOURMETER (If Equipped)

This meter is located on the range hood. It registers the total number of hours that the generator has been operated. Refer to the hourmeter to determine when periodic maintenance is due and to record services which have been performed.

*NOTE: While the generator is running it is normal for the hourmeter to make a periodic "ticking" sound.*

### GENERATOR OPERATION WARNINGS AND CAUTIONS

**WARNING**

The exhaust of all internal combustion engines contains carbon monoxide (CO). This poisonous gas is colorless, odorless, tasteless, and lighter than air. The exhaust systems of both your motor home engine and your generator engine have been installed with your safety in mind. However, certain precautions must be taken when using them to protect yourself from conditions beyond the control of the manufacturer.

1. **Do not** simultaneously operate the generator engine and a ventilator which could draw exhaust gases into the vehicle.
2. **Do not** open windows or ventilators on the end or side of the vehicle where exhaust pipe of the generator is located.
3. **Park the vehicle** so that the wind will carry the exhaust away from the vehicle. Also, note the position of other vehicles to be sure their exhaust will not enter your vehicle.
4. **Do not** operate the generator engine when parked if vegetation, snow, buildings, vehicles, or any other object can deflect the exhaust under or into the vehicle.

Check auxiliary generator oil level frequently during periods of use. Refer to the generator manufacturer's information in your Motor Home

Operations Manual binder for specific recommendations.

**WARNING**  
Never check generator oil level while generator engine is running.

## 12-VOLT DC SYSTEM

The DC voltage system consists of the automotive battery and the 12-volt motor home auxiliary batteries.

### Automotive (Starting) Battery

The automotive battery is used solely to operate the engine starter and all automotive accessories and controls found on the instrument panel. This includes the horn, speed control, all exterior lights, radio, windshield wipers, rear auto heater fan, etc.

### Coach Batteries

The coach batteries supply current to all 12-volt equipment located in the living area of the motor home. This includes interior lights, range exhaust fan, furnace fan, water pump, water level and holding tank gauges, 110-volt generator starting, refrigerator, bath roof vent fan, and the rear automotive heater. The coach battery may also be used to start the engine if the automotive battery is dead. Refer to "Aux. Start Switch."

The coach batteries are "deep-cycle" type batteries specially designed for recreational vehicle use. They will provide longer lasting power than standard automotive batteries, and will withstand the frequent drain-and-recharge cycles that occur under the demanding conditions of a camping outing.

The coach batteries are automatically charged by the engine alternator while the engine is running.

## 12-VOLT COACH FUSES AND CIRCUIT BREAKERS

All 12-volt circuits and equipment in the coach area of the motor home are protected by either a fuse panel or breaker panel. When a circuit is overloaded or a short develops in any part of the system, a fuse or breaker will shut down that circuit. If this happens, turn off all affected lights or appliances and reset the breaker or replace the

fuse with a new one of equal amperage rating.

A label on the panel states the amperage rating and circuit protected for each fuse or breaker.

## FUSE PANEL

The fuse panel is mounted on the right-hand side of the power converter.

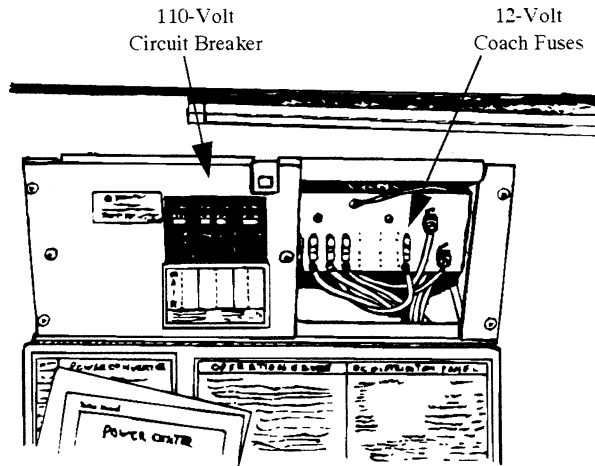

The fuse panel accepts only blade type plug-in fuses. Always replace fuses with those of the same amperage rating.

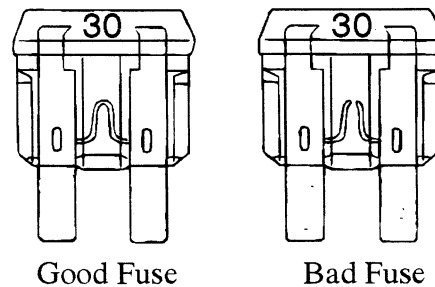

## BATTERY INFORMATION

### AUTOMOTIVE BATTERY ACCESS

The automotive (starting) battery is located in the engine compartment.

### AUXILIARY (COACH) BATTERY ACCESS

The auxiliary battery is located in an exterior battery storage compartment for convenient access for periodic inspection or maintenance.

To service or remove the batteries, unfasten the retainer strap and disconnect battery cables.

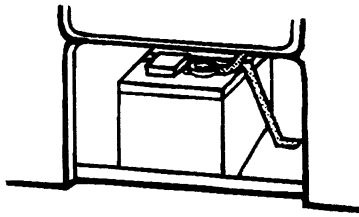

Coach Battery Storage

### WARNING

Refasten the retainer strap when returning the battery to the compartment.

## BATTERY STORAGE AND MAINTENANCE

Lead-acid type batteries are electro-chemical devices for storing and releasing electrical charge. As such, they are simply an electrical reservoir, not an electrical source. As soon as energy is removed from the battery, it should be replaced by the engine alternator or the RV converter system.

If a battery sits unused for 30 days or more, especially during warm weather, it can develop a deposit of sulfate crystals on the metal plates inside the battery. This condition is called sulfation or sulfating, and prevents the battery from either releasing or accepting a charge. If this condition occurs, the battery must be replaced.

If a battery does not contain at least 80% charge during freezing temperatures, the electrolyte can freeze and crack the battery case.

The two best defenses against either sulfating or insufficient charge are:

1. To disconnect the battery cables to avoid any "parasitic" discharge, and
2. to check the battery and recharge as necessary at least once a month during long periods of storage.

A further precaution is to remove the battery from the vehicle and store it in a cool location on a wooden or rubber pad, checking charge periodically to avoid discharge or sulfating.

To ensure that the battery will always accept and hold a charge, follow these simple maintenance practices.

- Make sure the batteries always remain securely clamped in the battery tray.
- Make sure battery cable clamps are tight on the terminal posts and are free of corrosion.
- Neutralize corrosion buildup or acid film on top of battery by washing with a baking soda/water solution. Rinse with clear water.

*NOTE: Make sure vent caps are on securely to prevent baking soda solution from entering the battery and contaminating the electrolyte fluid.*

### WARNING

Before removing any battery cables or battery, make sure all 12-volt equipment in the motor home is off and the power cord has been disconnected.

Replace any damaged cables at once.

Always remove jewelry and wear protective clothing and eye covering when checking or handling batteries.

Refasten the retainer strap when returning the battery to the compartment.

- Clean and tighten battery terminals and have the specific gravity checked at least once a year.
- Every two months, or more often in hot weather, check the battery fluid level. Fill to approximately 3/8 inch above the plates. **DO NOT OVERFILL.** If fluid is added during freezing weather, the motor home should be driven several miles to mix water and electrolyte to prevent freezing.
- Fluid level check may be omitted if equipped with maintenance-free batteries.



**WARNING**

To prevent damage to batteries or wiring, always observe battery polarity. Always attach positive (+) cable to positive terminal and negative (-) cable to negative terminal. The battery terminals are marked (+) and negative (-).

Disconnect both battery cables before connecting a "booster" battery charge to a battery inside the battery compartment.

Never try to charge or boost a frozen battery. A battery explosion could result.

TM = Tail lights  
GD = Ground  
LT = Left Turn  
RT = Right Turn  
S = Brake lights  
A = Backup lights

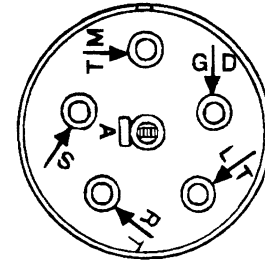

**BATTERY CONDITION METER**

This meter allows you to check the level of charge in the coach battery in your motor home. It is located on the monitor panel in the galley area. (See Section 8.)

To obtain an accurate reading:

1. Both the automotive engine and the auxiliary generator engine must be stopped.
2. An interior light should be turned on to provide a small load which draws off battery surface charge.

**AUX. START SWITCH - See page 2-8.**

**TRAILER WIRING CONNECTOR**

Your coach is pre-wired for trailer or car towing lights with a 6-pin socket on the rear bumper. The connector plug is supplied in the coach parts package provided to you by your dealer when you took delivery of the vehicle.

The diagram shows proper connection of trailer or tow vehicle wiring to the coach light system. Remove the small screw near the end of the plug and slide the contact assembly out of the barrel.



### FRESH WATER SYSTEM

The fresh water system provides water to the galley sink, shower, bathroom lavatory, toilet and water heater. Water may be supplied by either of two sources:

- a water tank located within the motor home, or
- any external water source to which the motor home may be connected, known as "city water".

### FRESH WATER TANK FILLING PROCEDURES:

Always fill the fresh water tank at an approved potable water filling facility or a known purified drinking water source.

The tank may be filled by inserting a hose into the tank fill opening. A built-in vent prevents the tank from becoming air-locked while filling.

When neither city water nor a hydrant are available, a bucket and funnel may be used to fill the tank, but this can take a considerable amount of time.

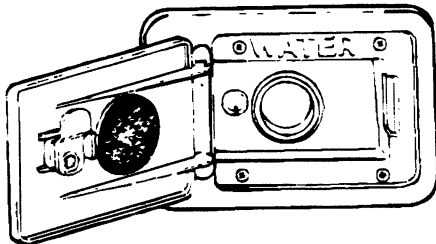

WATER TANK FILL

Fresh Water Tank Capacity	
All Models	31 gal.

### WATER PUMP

Pressure for the water system is supplied by a water system demand pump which is fully automatic after initial priming. When a faucet is opened, the pump begins operation to provide a constant flow from the tank. When the faucet is closed, the pump automatically shuts off.

### WATER PUMP SWITCH

The water pump switch is located on the water/holding tank monitor panel (See Section 8). If your vehicle is not equipped with a monitor panel, the switch will be located on a lower cabinet, the panel below a bed, or on the wardrobe wall panel, depending upon model. While the switch is in the "ON" position, the pump will automatically supply water pressure as it is needed. It is recommended that the pump switch be turned off whenever you are away from the vehicle or not using the water system. A slow leak in a faucet could drain the water system and discharge the coach battery.

### INITIAL START-UP

1. Make sure that all water drain valves are closed, including water heater valve. (Refer to Section 10.)
2. Turn water pump switch to "OFF" position.
3. Fill water tank.
4. Open all faucets, hot and cold.
5. Turn on pump switch.
6. Close each faucet as it begins to deliver a steady stream of water (close cold water first). Leave hot water faucets on until they also deliver a steady stream of water. This will ensure that the water heater is filled with water.
7. Check to be sure pump stops soon after all faucets have been closed.
8. Pump is now ready for automatic operation. Pump will start when a faucet is opened and stop when the faucet is closed.

### INSTRUCTIONS FOR DISINFECTATION OF FRESH WATER SYSTEMS ON RECREATION VEHICLES

(As approved by the U.S. Public Health Service)

To assure complete disinfection of your fresh water system, it is recommended that the following procedure be followed on a new system, one that has not been used for a period of time, or one that may have become contaminated. This procedure is also recommended before long

periods of storage such as over winter.

1. Prepare a chlorine solution using 1 gallon of water and 1/4 cup of household bleach (sodium hypochlorite solution). With tank empty, pour chlorine solution into the tank. Use 1 gallon solution for each 15 gallons of tank capacity. This procedure will result in a residual chlorine concentration of 50 ppm in the water system. If a 100 ppm concentration is required as discussed in item 3, use 1/2 cup of household bleach with 1 gallon of water to prepare the chlorine solution. One gallon of the solution should be used for each 15 gallons of tank capacity.
2. Complete filling of tank with fresh water. Open each faucet and run the water until a distinct odor of chlorine can be detected in the water discharged. Do not forget the hot water taps.
3. Allow the system to stand at least 4 hours when disinfecting with 50 ppm residual chlorine. If a shorter time period is desired, then a 100 ppm chlorine concentration should be permitted to stand in the system for at least 1 hour.
4. Drain and flush with fresh water.

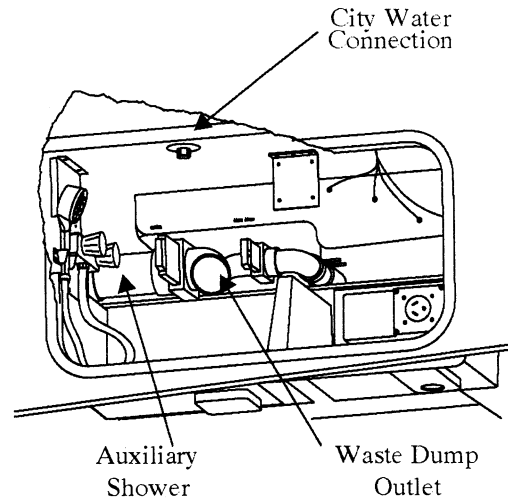

When connected to an outside source of water, the water bypasses the demand pump and storage tank and supplies pressure directly to individual faucets and toilet. A check valve built into the pump prevents water from entering the pump and filling the storage tank.

**To disconnect from the external source:**

1. Turn the external source off.
2. Open a faucet inside the vehicle to relieve line pressure.
3. Disconnect the hose from the coach.
4. Stick your finger up inside the connection and gently press the backflow valve upward to drain any water left in the line
5. Replace the protective plug back into the threaded collar on the connection.

**WARNING**  
Chlorine is poisonous - recap bottle and clean utensils after use.  
  
Never use automotive type antifreeze in your potable water system as it is poisonous.

**SHOWER VALVE PRESSURE BLEED-OFF**

After using the shower, you may notice water dripping from the shower faucet assembly. The dripping results when vacuum in the shower hose (after closing the shower faucet) slowly releases and allows water remaining in the hose to drain down. This is a normal function of the shower valve assembly and is not a leak or defect.

The International Association of Plumbing and Mechanical Officials Standard TSC 21-85 (PAR. 4.3) states:

“Shower heads which incorporate shutoff valves, shall have a minimum “drip rate” of one (1) quart in thirty (30) minutes.”

**EXTERNAL WATER SUPPLY (“City Water”)**

**To connect to an external source:**

1. Turn the demand pump switch to off.
2. Attach a hose from the external water source to the city water connection in the utility compartment on the left side of your vehicle.
3. Turn on the external water source.

### CAUTION

If items are placed into the shower tub before shower valve vacuum release is complete, they may become wet.

### EXTERIOR SHOWER

The exterior auxiliary shower feature allows you to do things such as rinse off sand or salt after a swim, rinse off muddy boots, or bath your pet outside the coach.

The shower is located in the utility system compartment on the left side of the coach, just ahead of the rear wheels.

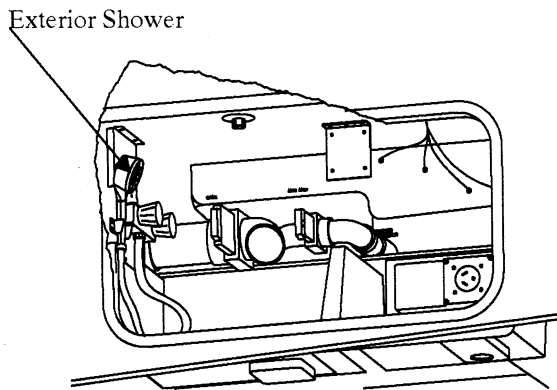

### WASTE DRAINAGE SYSTEM

The waste drainage system is self-contained, allowing use of the toilet, sinks, or shower even in areas where hook-up is not available. The drainage system may have two or three holding tanks depending on model and floor plan.

The holding tanks are dumped through a common outlet located on the left side of the vehicle, near the rear wheels.

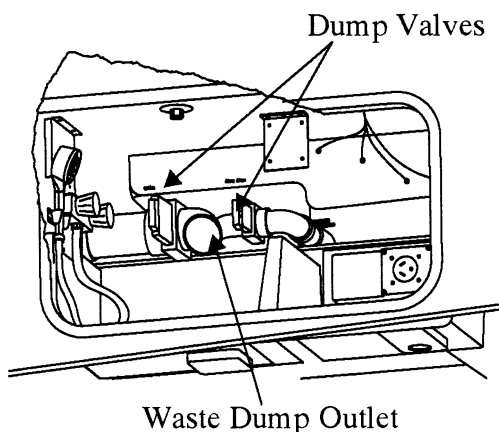

### DUMPING HOLDING TANKS

1. Remove drain hose from rear bumper or exterior storage compartment.
2. Remove dust cap from drain and connect drain hose. Be sure it is firmly attached.
3. Place the other end of sewer hose into disposal opening.
4. Open the (large) sewage valve with a quick pull. **OPEN ONE VALVE AT A TIME.** Move hose gently about to dislodge any waste and to ensure complete drainage.

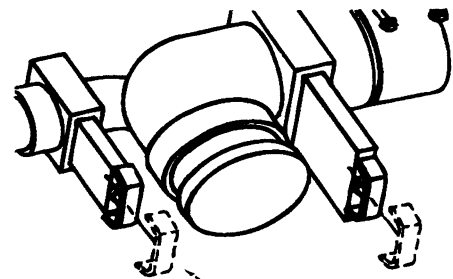
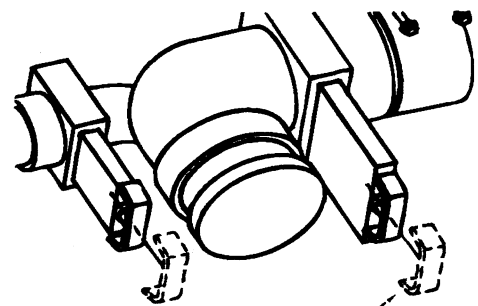

5. Close sewage valve and open (small) waste water valve with a quick pull. Make sure there are no sags in the hose during drainage. Close valve handle as soon as tank is empty.
6. After both tanks have been drained, run several gallons of water into the sewage tank through the toilet. Then open sewage dump valve and drain the tank again. Close valve and replace dust cap securely.
7. It is advisable to add an odor control chemical to the sewage holding tank. These chemicals are available at most R.V. stores.
8. Rinse sewer hose thoroughly with water and stow.

*NOTE: We recommend that you dump all holding tanks before traveling to avoid carrying unnecessary weight.*

### USING ON-SITE SEWER HOOK-UPS

The drain hose may remain attached to the dump outlet and be routed out the bottom of the compartment while the motor home is parked and connected to an on-site sewage hook-up.

When using a sewer hook-up, keep the dump valves closed until a tank becomes full or when preparing to leave the site. This keeps the solids in suspension, allowing them to be carried out with the liquids when the dump valve is opened. If the valve is left open, the liquids will drain off, leaving solids in the tank. Should this accidentally happen, disconnect the hose, fill the tank about half full with water, and drive a few miles to dislodge the solids. A few starts and stops will aid in the process. Then reconnect the hose and drain in the normal manner.

### HOLDING TANK LEVEL INDICATORS

The holding tanks may be monitored on the wall mounted monitor center.

Press the "Levels Test" switch to check the level in each tank.

See Section 8 - Appliances for further information on the monitor panel.

### WATER DRAIN VALVES

The water drain valves are used to drain water from the water tank and the water supply lines when preparing the motor home for storage or when sanitizing the water system.

To open or close the drain valves, turn the handles in the directions indicated by the following illustration.

Drain valve locations are listed on the following pages.

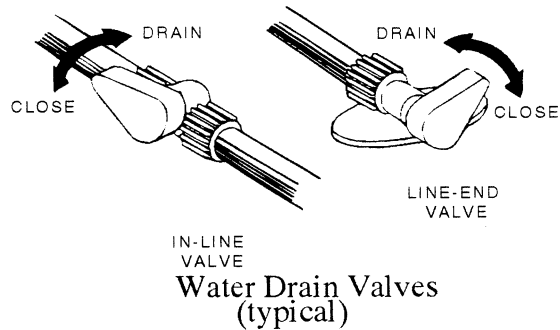

### Water System Winterization Valve

Your coach is equipped with a manually operated water line winterization system for your convenience in winterizing fresh water lines.

The system features a diverter valve and suction tube in-line between the tank and water pump to draw non-toxic RV water system anti-freeze into the water lines. This feature is located near the water pump and drain valves. See page 7-6 for location in your coach.

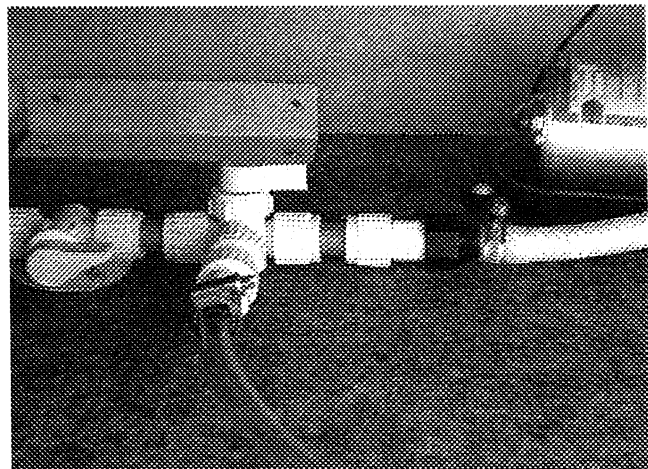

#### *To Fill Lines with RV Water Line Antifreeze*

- Turn water heater by-pass valve to BY-PASS position.
- Remove and save the protective cap from the end of the suction tube.
- Insert the end of the tube into a container of RV antifreeze solution.
- Turn the diverter valve handle so that it points toward the suction tube.
- Turn a water pump switch on.
- Open each cold water faucet handle in the coach one at a time until antifreeze solution

just begins to flow from the faucet, then close.

*When Done Adding RV Antifreeze:*

- Turn water pump switch off.
- Turn the diverter valve handle so it points toward the water line to the pump as shown in the photo. This will stop the flow from the suction tube and revert the tank line flow to the pump.
- Replace the protective cap onto the end of the suction tube to keep out insects and debris when not in use.

**CAUTION**

Leave by-pass valve handle in **NORMAL FLOW** position if draining water and blowing out water lines. Place in **BYPASS** position **ONLY** when using antifreeze solution in water lines.

**HOLDING TANK CAPACITIES**

**Black Water Holding Tank (Tank 1)**

Model 429WQ (Toilet & Lavatory).....	34 gal.
Model 429WU (Toilet & Lavatory).....	34 gal.
Model 431WU (Toilet) .....	34 gal.

**Gray Water Holding Tank (Tank 2)**

Model 429WQ (Galley & Shower).....	31 gal.
Model 429WU (Galley & Shower).....	31 gal.
Model 431WU (Lavatory, Galley & Shower) .....	34 gal.

<b>WATER SYSTEM DRAIN VALVE LOCATIONS</b>		
<b>MODEL</b>	<b>SYSTEM</b>	<b>DRAIN VALVE LOCATIONS</b>
429WQ	Water Lines:	One (1) valve behind hinged access panel in passenger side rear cargo compartment. Also open exterior shower faucet and place shower head below floorline.
	City Water Line:	The city water hose connection is located on the “ceiling” of the Utility System compartment. Stick your finger up inside the connection and gently press the backflow valve upward to drain any water left in the line.
	Water Tank:	One (1) valve behind hinged access panel in passenger side rear cargo compartment.
	Water Heater:	Drain plug on outside of coach, behind service door. Use socket to remove drain plug.
	Water Heater By-Pass Valve:	Behind access panel beneath galley cabinet.
	Winterization (Antifreeze) Valve:	Behind hinged access panel in passenger side rear cargo compartment.
429WU	Water Lines:	One (1) valve behind hinged access panel in passenger side rear cargo compartment. Also open exterior shower faucet and place shower head below floorline.
	City Water Line:	The city water hose connection is located on the “ceiling” of the Utility System compartment. Stick your finger up inside the connection and gently press the backflow valve upward to drain any water left in the line.
	Water Tank:	One (1) valve behind hinged access panel in passenger side rear cargo compartment.
	Water Heater:	Drain plug on outside of coach, behind service door. Use socket to remove drain plug.
	Water Heater By-Pass Valve:	Behind access panel beneath galley cabinet.
	Winterization (Antifreeze) Valve:	Behind hinged access panel in passenger side rear cargo compartment.

**SECTION 7**  
**PLUMBING SYSTEMS**



431WU	<p>Water Lines:</p> <p>City Water Line:</p> <p>Water Tank:</p> <p>Water Heater:</p> <p>Water Heater By-Pass Valve:</p> <p>Winterization (Antifreeze) Valve:</p>	<p>One (1) valve behind hinged access panel in passenger side rear cargo compartment. Also open exterior shower faucet and place shower head below floorline.</p> <p>The city water hose connection is located on the “ceiling” of the Utility System compartment. Stick your finger up inside the connection and gently press the backflow valve upward to drain any water left in the line.</p> <p>One (1) valve behind hinged access panel in passenger side rear cargo compartment.</p> <p>Drain plug on outside of coach, behind service door. Use socket to remove drain plug.</p> <p>Behind access panel beneath galley cabinet.</p> <p>Behind hinged access panel in passenger side rear cargo compartment.</p>
-------	---	---



(See also Safety Precautions, Section 1 of this manual.)

*NOTE: Because this model is available in several sizes and floor plans, some items described may be optional or unavailable on your coach.*

The appliances installed in your motor home are manufactured by reputable RV appliance makers and have been tested by independent laboratories to meet all applicable standards and codes set for RV appliances. These appliances are covered by your New Vehicle Limited Warranty. (Certain items may be covered by individual manufacturer's warranty.) See your New Vehicle Limited Warranty for details.

### REFRIGERATOR

The refrigerator in your coach can be operated from either of two power sources available to the motor home:

- 110-Volt AC electric
- LP gas

The refrigerator is an absorption type which uses an ammonia-water solution for cooling. Basically, ammonia vapor is distilled from the solution by heat, produced from either LP gas or electricity and then carried to the finned condenser where it liquefies. The liquid then flows to an evaporator where it creates cold temperatures through evaporation.

### LEVELING

Before operating the refrigerator when the motor home is stationary, place a small level on the freezer plate and make certain the unit is level.

### CAUTION

To prevent permanent damage to the refrigerator cooling unit, turn the refrigerator off if the vehicle will be parked on an incline of over 3° side-to-side or 6° front-to-rear (such as steep driveways or parking lots, etc.) for more than one hour.

Normal vehicle leveling to provide comfort for the occupants is satisfactory for refrigerator operation. This will be well within the operation limits of 3° off-level side-to-side and 6° off-level front-to-back.

### OPERATING INSTRUCTIONS

#### Norcold Model 900-Series Models with Electronic Auto Mode Control

#### Start-Up Instructions - Gas Mode

The control panel is located between the freezer compartment and fresh food compartment. It contains pressure sensitive touch switches and LED display. The AC, LP GAS, Battery, and AUTO LED's (A) illuminate to indicate the refrigerator's operating mode.

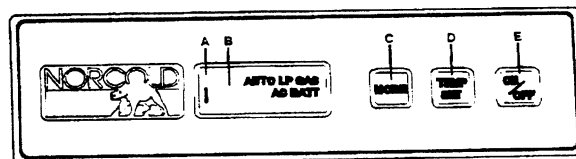

The ON/OFF button (E) turns the refrigerator On or Off. If the button is pressed, it will turn the refrigerator On and set the mode to AUTO. When the refrigerator is On, pressing this button for 2 seconds will turn the refrigerator Off.

Pressing and holding the MODE button (C) allows the user to cycle through the three mode choices; one AUTO and two manual modes (AC, LP GAS). The refrigerator will not switch to the

new operating mode until the mode button is released.

The TEMP SET (thermostat) button (D) controls the refrigerator and freezer temperature during both gas and electric operation. Press and hold the TEMP SET button to select the desired temperature setting. The temperature settings are shown in the form of LED's (A). The illuminated LED indicates the temperature setting, with COLD on the left and COLDEST on the right. The temperature LED turns off after 10 seconds. Quickly press and release any button to display the temperature setting.

### Start-Up Instructions - Auto Mode

When the AUTO mode is selected, the operating control automatically selects the power source using the following priority scheme:

- When 120 volts AC is available to the refrigerator, the AUTO LED and the AC LED will illuminate, indicating the refrigerator is operating on AC electric. After 10 seconds, the AC LED will turn off and only the AUTO LED will remain illuminated. Press and quickly release any button to display the operating mode.
- If 120 volts AC is not available, the refrigerator will switch to the gas operation. The AUTO LED and the LP GAS LED will illuminate. After 10 seconds, the LP GAS LED will turn off and only the AUTO LED will remain illuminated. Press and quickly release any button to display the operating mode.

During operation in the AUTO mode, when a higher priority power source becomes available, the operating controls will cease using the current power source and will switch to the higher priority power source. For example, if AC electric becomes available while the refrigerator is operating in the AUTO LP GAS mode, the refrigerator will switch to AUTO AC operation.

If an operating mode is not functional, its corresponding LED will flash and the refrigerator will attempt to operate in a lower power priority source. If a lower power priority source is

not available, the LED will continue to flash, and the refrigerator will cease operation until the energy source is corrected. Refer to the "Diagnostic" section on page 7 of the "Norcold 9100 Series Refrigerators Operator's Guide" in your blue binder.

### Start-Up Instructions - Manual Mode

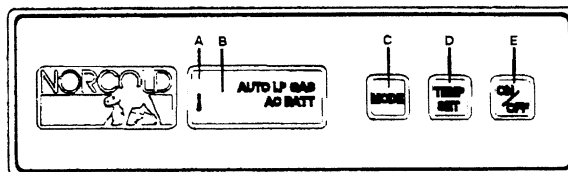

To operate the MANUAL mode, press and hold the MODE button (C) until the AUTO LED disappears and the desired operating mode is displayed. If the power source is interrupted while operating in the MANUAL mode, the AUTO LED disappears and the desired operating mode is illuminated. Unlike AUTO mode, the operating mode LED remains illuminated until an alternate mode is selected. If the energy source is interrupted while in the MANUAL mode, the corresponding LED flashes, and the refrigerator ceases operation until an alternative energy source is selected or the problem is corrected. Refer to the "Diagnostics" section on page 7 of the Norcold Operator's Guide in your blue binder for corrective actions.

### AUTO and MANUAL Modes - Gas Operation Only

If the gas does not ignite within 30 seconds, which may occur on initial start-up, the refrigerator's gas valve will automatically close and the operating controls will select an alternate power source (AUTO Mode) or revert to a stand-by mode in which the LP GAS LED flashes. The LED continues to flash until the refrigerator is turned OFF and then ON. If the gas does not ignite after several attempts, check the input gas supply, or consult with your dealer or a Norcold authorized service center. A different mode of operation may be selected by pressing and hold-

ing the MODE button. The refrigerator will not switch to the new operating mode until the MODE button is released.

## **Backup Operating System (“BOS”)**

Your refrigerator features a Backup Operating System which keeps the refrigerator cool in the event of a failure of the refrigerator’s operating controls. If a failure occurs, the TEMP SET LED flashes and refrigerator switches to the BOS mode. This mode provides refrigeration until the refrigerator is serviced. The fresh food and freezer compartment temperatures should be monitored to prevent over-freezing or thawing of refrigerator contents when operating in the BOS mode. If the refrigerator temperature is too cold, adjust the thermostat to the left in single LED increments. If the refrigerator temperature is too warm, adjust the thermostat to the right in single LED increments. Let the refrigerator operate at the new setting for one hour before rechecking the freezer and fresh food compartment temperatures. (Frequent door opening prevents the temperatures from stabilizing.) Although the refrigerator can operate in this mode, Norcold recommends that you seek service to restore manual operation as soon as practical.

## **HUMIDITY - STORAGE SWITCH**

Turning this switch to HIGH HUMIDITY will keep the surface between the door openings dry during high humidity conditions. The switch should be left in the NORMAL OPERATION position unless moisture collects around the door.

When storing your RV for the winter, place this switch in the STORAGE (LIGHT OFF) position. This shuts off all DC power to the light and humidity heater and allows the refrigerator door to be left open for airing without draining the battery.

## **HUMIDITY - STORAGE SWITCH**

Turning this switch to HIGH HUMIDITY will keep the surface between the door openings dry during high humidity conditions. The switch

should be left in the NORMAL OPERATION position unless moisture collects around the door.

When storing your RV for the winter, place this switch in the STORAGE (LIGHT OFF) position. This shuts off all DC power to the light and humidity heater and allows the refrigerator door to be left open for airing without draining the battery.

## **OPERATING TIPS**

- The refrigerator should already be cold before placing items in it.
- Food and beverages should also be cold before placing in RV refrigerator. Never put warm or hot items in a cold refrigerator.
- Do not pack the refrigerator too full. The refrigerator needs room for cold air to circulate.
- Use smaller containers for each item. (e.g. a half gallon container of milk instead of a half-full gallon jug)
- Always put foods, especially liquids, in tightly sealed containers.
- Use crumpled paper between loose items to reduce rattling or “clinking” noises.

## **Further Information**

For further information and operating cautions, see the Norcold refrigerator operating instructions included either inside the refrigerator or in your Motor Home Operations Manual binder.

## **REFRIGERATOR COMPARTMENT (Exterior)**

The exterior refrigerator compartment allows access to the rear of the refrigerator for inspection, maintenance and service.

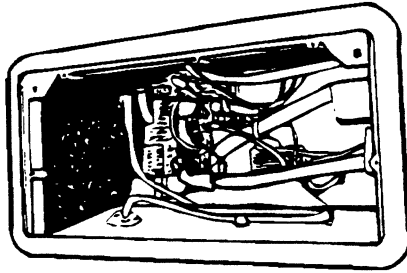

Refrigerator Access Compartment

**To Open:**

1. Use a coin to turn the latch knobs to the vertical position as shown.
2. Remove the door from the opening.



CLOSE

OPEN

Refrigerator Access Door Latches

**To Close:**

1. Replace the door into the opening.
2. Push the latch knobs in while turning to the horizontal position as shown.

**RANGE AND OVEN**

The range and oven in your motor home are operated on LP gas and will provide nearly all of the functions that the range in your home does. One benefit of gas burners is that heat is available as soon as a burner is lit, as opposed to an electric element slowly heating up. The range has a "Pilot Off" position on the oven control which allows the oven pilot to be turned off when traveling or refilling the LP tank.

The following warning label has been located in the cooking area to remind you to provide an adequate supply of fresh air for combustion.

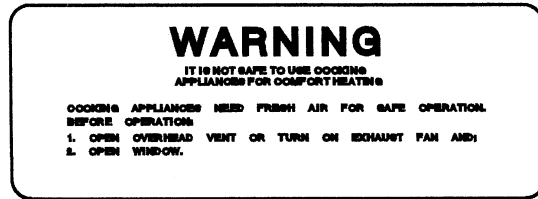

Unlike large homes, the oxygen supply inside a recreational vehicle is limited due to its size. To avoid danger of asphyxiation, provide proper ventilation when using the gas rangetop or gas oven. It is especially important not to use the gas oven and range top for comfort heating. Danger of asphyxiation is greater when these appliances are used for long periods of time.

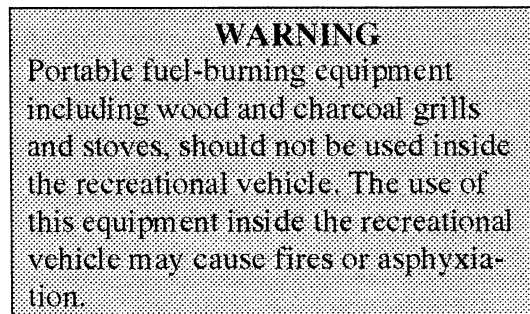

**Use of Top Burners**

1. Light match.
2. Apply lighted match to burner.
3. Turn control knob back left (counterclockwise to the "LITE" position).
4. When the burner lights, adjust the flame height by turning the knob back toward the "OFF" position.

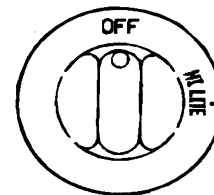

**WARNING**  
Do not turn burner control knob to "On" and allow gas to escape before lighting match.

### LIGHTING OVEN PILOT

*NOTE: If range has not been operated for a long period of time, a longer waiting period for ignition of the pilot may be necessary due to air in the gas line.*

1. Be sure all valves are in the "OFF" Position. The oven control knob should be in "OFF" position.
2. Turn on main gas supply to range.
3. Press and turn control knob to the "PILOT ON" position. This will allow gas to oven pilot.
4. Open oven door and light oven pilot with a match. Small flame will be noted at the

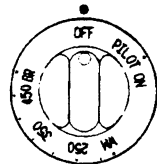

Oven Control Knob in "OFF" position

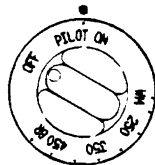

Oven Control Knob in "PILOT ON" position

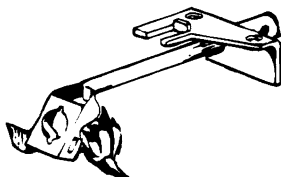

Lighting oven pilot (when pilot is located on left side of burner.)

### OPERATING OVEN CONTROL

Push in and turn the oven control knob (counterclockwise) to the desired temperature setting.

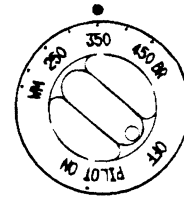

There is a delay of about 45 seconds before the main burner ignites. This is normal and there is no gas escaping during this delay. It is also normal for the oven burner flame to cycle off and on at all temperatures except broil (BR).

### SHUT DOWN INSTRUCTIONS

When oven cooking is finished, turn the oven control knob to the "PILOT ON" position, the oven standby pilot will remain lit.

When the recreational vehicle is not in use or while traveling, turn the oven control knob to "OFF" position and turn off main gas supply; this will turn off the oven pilot.

### MICROWAVE OVEN

For complete operating instructions, refer to the manufacturer's information provided with the oven.

### RANGE HOOD

The range hood vent allows you to exhaust cooking odors and gas fumes to the outside of the coach and to supplement fresh air ventilation. A light on the underside of the hood provides better illumination for food preparation.

The monitor panel is built into the face of the range hood. It provides central location of switches for the hood fan, hood light, water pump and tank level indicator lights.

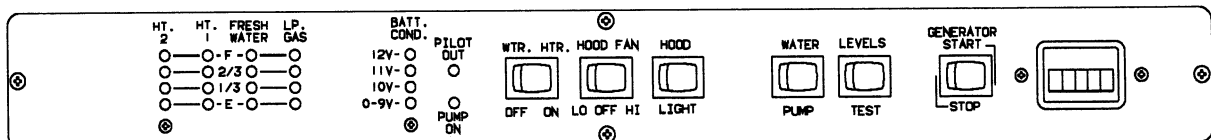

At the push of a single button this monitor panel simultaneously displays the coach battery condition and levels of the water tank, holding tanks and LP tank. It also contains the water pump power switch and an indicator light to show when the pump switch is on.

The auxiliary electric generator start/stop switch and hourmeter are also located on the range hood panel. See Section 6 for generator starting and stopping instructions and operating precautions.

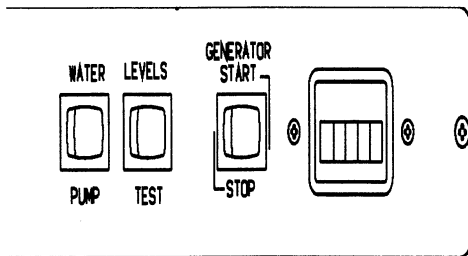

### HOOD FAN AND LIGHT SWITCHES

To turn on the range hood light, simply press the switch labeled "Hood Light". To operate the range hood fan, press the "Hood Fan" switch.

### WATER HEATER SWITCH

Be sure the water heater is filled with water before pressing this switch. To fill the water heater, turn the water pump switch on and open a hot water faucet until water begins to flow.

On electronic ignition models, the "W.H. Out" light will glow for about 10-15 seconds after the water heater switch is turned on, then it will go off. If the light comes on during normal operation, it means that the burner has gone into "lockout" mode. Turn the switch off for about 5 minutes, then turn back on. See "Water Heater" elsewhere in this section for further information.

### WATER AND HOLDING TANK LEVELS

Press and hold the "Levels Test" switch to show approximate level on the monitor lights.

These approximate water levels are measured by electronic probes in the sides of the tanks, so the water must be touching a probe to register at that level. There is generally more water in a tank than indicated on the monitor panel.

For example, if the water level of 1-2" below

the FULL probe, the monitor will show the level to be only 2/3 even though the tank is nearly full. If the water level is below the 1/3 probe, the monitor will register an empty tank because the water is no longer touching the 1/3 probe. There may actually be some water left in the tank. However, when the indicator reads FULL, the tank is actually full.

### LP GAS LEVEL

Press and hold the "Levels Test" switch to show approximate LP tank level.

The LP level is registered by a sending unit on the tank. The gauge mounted on the side of the tank will give a more accurate indication of actual tank level if needed.

### WATER PUMP SWITCH

When use of the self-contained water system is desired, turn the "Water Pump" switch on. The "Pump On" light will illuminate when the pump switch is on and the system is operable. Water will be available as soon as a faucet is opened. Refer to "Fresh Water System" for additional information on the water pump and initial start-up.

### BATTERY CONDITION METER

Push the "Levels Test" button to check the level of charge (voltage) in the 12-volt coach battery. The colored segments (red, yellow and green) will light from the bottom up to the amount of charge the battery contains.

- \* Green - good or adequate charge.
- \* Yellow - marginal charge.
- \* Red - battery needs charging before use.

### Water Heater Switch and "W.H. Pilot" Indicator

Be sure the water heater is filled with water before pressing this switch. To fill the water heater, turn the water pump switch on and open a hot water faucet until water begins to flow.

The "W.H. Pilot" light will glow for about 10-15 seconds after the water heater switch is turned on, then it will go off.

If the "W.H. Pilot" light comes on during normal operation, it means that the burner has gone into "lockout" mode. Turn the switch off for about 5 minutes, then turn back on.

## WATER HEATER

### Direct Ignition Model GH6-6E, GH6-6E, and GCH6-6E

1. Place Water Heater switch in the "On" position. The switch and "WH Pilot" light are located on the lower face area of the galley cabinet.
2. If "W.H. Pilot" light stays on longer than 15 seconds, place switch in "Off" position and wait 5 minutes.
3. Repeat step one.
4. If heater fails to operate due to high water temperature, the heater will go into a lockout condition ("W.H. Pilot" light on). When water cools, reset by placing switch in "Off" position for at least 30 seconds, then return to "On" position.
5. If a lockout condition persists: contact your dealer, an Atwood Service Station or Atwood Service Department (Phone: 815-877-5700).
6. For complete shut-down before servicing:
  - a) Place Water Heater switch in "Off" position.
  - b) Remove red wire from left-hand terminal of ECO switch (ECO to valve).

#### CAUTION

The temperature knob or lever is factory adjusted to its lowest setting. We recommend the mid-point position between warm and hot, as noted above. This will provide for energy efficient operation and sufficiently hot water. Setting at a higher position will produce a higher temperature and increase the risk of being scalded.

### WATER HEATER PRESSURE-TEMPERATURE RELIEF VALVE

On occasion, water may be seen seeping from the water heater pressure temperature relief valve. This is no cause for repair or replacement of the valve.

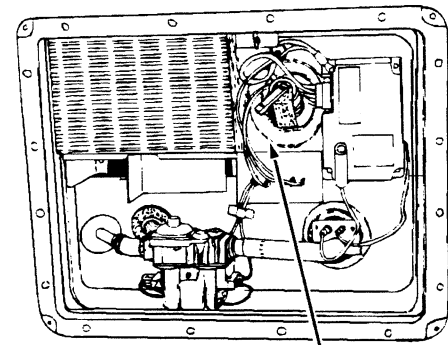

WATER HEATER  
OUTSIDE ACCESS

P-T Relief  
Valve

Normally there is an air gap at the top of the water heater tank which acts as a pressure buffer. In time, however, heated water may expand and fill this air gap, causing a slight increase in water pressure. This may cause the P-T valve to "weep" until the air gap is manually replaced.

#### To Replace the Air Gap:

1. Turn off the water heater switch and incoming water supply (city water and/or demand pump).
2. Open a faucet in the motor home to relieve water pressure.
3. Pull the handle of the P-T valve straight out and allow water to flow until it stops.

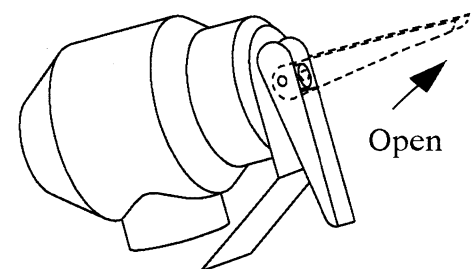

P-T Valve

4. Let the handle of the P-T valve snap shut.
5. Close the faucet and turn on the water supply before switching the water heater on.

Manually operate the pressure temperature relief valve at least once a year. **OPERATE THIS VALVE ONLY WHEN THE WATER HEATER AND COOLING SYSTEM ARE COLD!**

**WATER HEATER CAPACITY:** 6 gal.

### WATER HEATER BY-PASS VALVE

Your coach may be equipped with a water heater by-pass valve for easier winterization of water lines using RV antifreeze. The valve is located inside the coach near the water heater. See pg. 7-5 for the exact location in your coach.

Line up the arrow on the handle with the appropriate arrow on the valve plate to either by-pass or flow through the water heater.

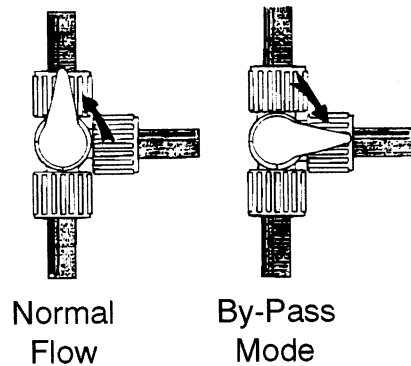

#### CAUTION

Leave by-pass valve handle in **NORMAL FLOW** position if draining water and blowing out water lines. Place in **BYPASS** position **ONLY** when using antifreeze solution in water lines.

### MOTOR AID (Optional)

The motor aid acts as a heat exchanger between the water heater and the vehicle engine. Two hoses from the water heater connect to the hoses which deliver hot water between the engine and the driver's compartment heater. A heat exchanger in the water heater then circulates the water from the engine radiator around the water heater tank. Under normal conditions, the entire contents of the water heater tank will be heated to approximately 140F in about two hours or 100 miles of driving.

In addition, the motor aid heat exchanger helps the vehicle engine to operate at cooler temperatures by dissipating heat from the engine. This reduces the possibility of overheating, particularly when operating in hot climates.

#### CAUTION

Any leak in the heat exchanger or its supply or return lines could cause loss of coolant and subsequent engine failure. We recommend that you periodically inspect these connecting lines and the heater to insure that no leaks have developed.

### Motor Aid Water Heater and Rear Auxiliary Heater Maintenance

Have your authorized dealer check all hose clamp connections on the rear automotive heater and the motor aid water heater at least every six months and tighten them if necessary.

### LP GAS FURNACE (SUBURBAN)

#### To Start Up:

1. Close the LP gas tank valve.
2. Turn thermostat switch ON.

#### Temperature Selector

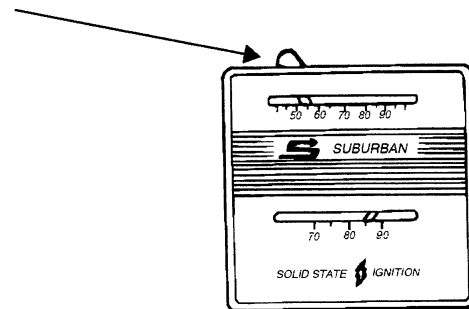

#### Thermostat Switch

3. Set thermostat above room temperature to begin blower operation. A slight delay will occur before the blower comes on. Allow blower to run for 5 minutes for combustion chamber purge cycle.
4. After 5 minutes, move thermostat lever below room temperature. Blower will remain on. Wait approximately 2 minutes for blower to go off.
5. Open LP gas tank valve.
6. Set thermostat to desired temperature. If set above room temperature, blower will come on.



7. Allow 30 seconds for main burner to light after blower comes on. This furnace is equipped with an ignition device which automatically lights the burner. Do not try to light the burner by hand.
8. If burner does not light, repeat Steps 1 through 5. (If heat does not come out of the heat duct after a minute or so, the burner is not lit.)
9. If after three (3) attempts with no ignition, go to shut-down and contact your dealer or a local recreational vehicle service center. Do not continue to cycle furnace through thermostat in an attempt to get ignition.

### To Shut Down:

1. Slide SYSTEM switch to "OFF" position.
2. Close LP tank valve.

*NOTE: For normal operation after initial start-up, be sure the SYSTEM switch is in HEAT position, then place the TEMPERATURE SELECTOR to the desired temperature. The furnace will start and cycle on and off automatically.*

### FOR FURTHER INFORMATION

Please see the Suburban furnace operating instructions provided in your Owner Information binder for further information, including operating precautions, and periodic maintenance.

### ROOF AIR CONDITIONERS

Refer to the manufacturer's information in your Motor Home Operations Manual binder for complete operating instructions.

### TV ANTENNA - Optional

The TV antenna on your motor home can be easily raised, rotated a full 360° and lowered from inside the vehicle by simply turning a crank or rotating knob. A built-in signal amplifier designed to strengthen signals, is controlled by a power switch built into the TV jack assembly.

The signal amplifier is housed inside the antenna with the circuit board connected directly to the antenna elements. Power to operate the amplifier (12-volt DC) is supplied through the download cable which also carries the TV signals

to the TV set. The power supply separates the 12-volt DC from the TV signals and provides a place for attaching the TV set and the 12-volt power source.

### OPERATION

**Raising Antenna** - Turn elevating crank clockwise in "UP" direction about 13 turns or until some resistance to turning is noted. Antenna is now in operating position. Turn amplifier power switch "ON" to receive TV signal.



### WARNING

Never allow the antenna to touch electrical power lines or any other electrical wires.

**Rotating Antenna** - Make sure antenna is in the "UP" position. Pull down on rotating knob until it disengages ceiling plate and rotate for best picture and sound on TV set.



**Lowering Antenna to Travel Position** - Rotate antenna until pointer on rotating knob aligns with pointer on ceiling plate.



**VEHICLE MAINTENANCE**

(See also Safety Precautions, Section 1 of this manual).

**CHASSIS SERVICE & MAINTENANCE**

Consult the appropriate sections in your chassis operating guide for specific information regarding operating safety, service recommendations and maintenance schedules for the chassis section of your motor home.

**ENGINE ACCESS**

Refer to your chassis operating guide.

**ENGINE COOLING SYSTEM**

Refer to your chassis operating guide for information and precautions on filling, servicing and checking the fluid level.

**CAUTION**

When refilling the coolant system of a vehicle equipped with a rear auxiliary automotive heater and motoraid water heater, be sure to allow for additional coolant capacity of the heater and its supply and return hoses.

**TIRES**

Low air pressure results in tire overloading and abnormal wear and also affects handling and fuel economy. Obtain proper inflation pressures from your chassis operating guide or tire manufacturer.

**WARNING**

Make sure all replacement tires are of the same size and ply rating as those installed as original equipment.

**SUSPENSION ALIGNMENT AND TIRE BALANCE**

The front suspension and steering system of this vehicle was factory aligned using highly accurate equipment prior to delivery to the dealership. However, we recommend that alignment be checked and adjusted, if necessary, after you have fully loaded the motor home according to your personal needs. Thereafter, the alignment

should be periodically inspected to help prevent uneven tire wear.

Any excessive or abnormal tire wear may indicate worn or misaligned suspension or steering, unbalanced tire or other tire/suspension problem.

Alignment can be affected by worn steering/suspension parts or by incidents which happen during driving, such as hitting a curb, pothole or railroad track, etc. Improper alignment can cause tires to roll at an angle and wear unevenly. It may also cause the vehicle to “pull” to the right or left. Have your dealer inspect your vehicle’s suspension and steering components periodically for misalignment or wear.

Out-of-balance tires will not roll smoothly and can lead to annoying vibrations and uneven tread wear such as cupping and flat spots. Tires may need to be balanced if uneven wear is detected or if ride comfort decreases noticeably.

See your chassis operating guide for further information.

**WINDSHIELD WASHERS AND WIPERS**

See your chassis operating guide for recommendations and precautions regarding washers and wipers.

**LIGHTS**

All exterior lights should be checked for proper operation each time the vehicle is prepared for a trip. Any bulbs which fail to light should be checked and replaced, when necessary, with a new bulb of the same size. A failure of more than one light, such as both taillights not operating, may indicate a burned out fuse. Check fuse and replace with one of the same rating when necessary. If a fuse is not the cause of the problem, the wiring system should be checked immediately by an authorized service center.

The headlight circuit is protected by a circuit breaker. An overload on the breaker will cause the lights to flicker on and off. Headlight wiring should be checked immediately anytime this condition is apparent. Refer to your chassis operating guide for further information.

**AUTOMOTIVE 12-VOLT FUSES AND CIRCUIT BREAKERS**

The automotive fuses and breaker are protected from short circuit and overload conditions by a fuse block. On most models, this is located beneath the dash to the left side of the steering col-

umn. See your chassis operating guide for additional fuse replacement information.

## AWNING INSTALLATION

*NOTE: See your Winnebago or Itasca dealer for installation of awnings. Your dealer's service department has information showing locations of awning bracket supports in the sidewall of the coach.*

**CAUTION**

Improper awning installation may result in damage to the coach.



### PREPARING VEHICLE FOR STORAGE

Properly preparing your vehicle for storage will lessen the possibility of damage to your vehicle. Prepare the motor home for vacancy just as you would if you were leaving your house for an extended period:

- Remove all perishables from cabinets and refrigerator
- Prop refrigerator door open.
- Turn off LP gas tank.
- Drain water heater, water tank and holding tank.
- Close shades to protect upholstery from sunlight

When storing your vehicle through the winter, or in cold climates, extra preparations need to be made to protect systems that can be damaged by freezing temperatures.

### Cold Weather Storage Procedure (Winterizing)

1. Clean and dump holding tanks by following steps A, B, and C
  - A. Add water to the sewage holding tank by holding the toilet flush lever open with the water pump running. Add water to the waste water holding tanks by opening the kitchen, shower and lavatory faucets. Tanks should be about 1/4 to 1/3 full to rinse properly. Driving to a disposal site will normally loosen and rinse any waste material from the sides of the tank.
  - B. Completely drain the sewage and waste water holding tanks at an approved waste disposal site. Drain the sewage tank first so the following waste water can rinse any waste solids from the dump outlet and sewer hose.
  - C. Close dump valves and refit the dust cap onto the drain outlet.
2. Level the motor home and drain the entire plumbing system as described in the following steps.
  3. Open all drain valves. (See the water system drain valve chart on page 7-5 for locations on your model.)
4. Turn the Water Pump switch ON to allow it to operate until you are done draining all faucets and toilet.
5. Open all faucets and shower head valves, including exterior shower.
6. Operate the toilet flush lever and hold until water stops flowing in the toilet. Then turn water pump switch OFF.
7. Turn off the water heater power switch before draining the water heater tank to avoid damage to the heating element.
8. Drain the water heater by removing the plug from the base of the water heater tank, accessible from the outside of the coach. (Requires socket and ratchet.) Also open the Pressure-Temperature relief valve at the top right portion of the tank to prevent air locking in the tank while draining.

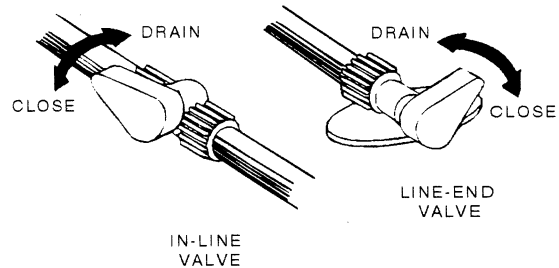

*NOTE: If your coach is equipped with a water purifier system, you will need to remove the filter cartridge and install the diverter plug supplied. The cartridge is located beneath the galley sink counter. The diverter plug must be removed and a filter cartridge installed before resuming normal use of the water system. The plug is intended for winterization only.*

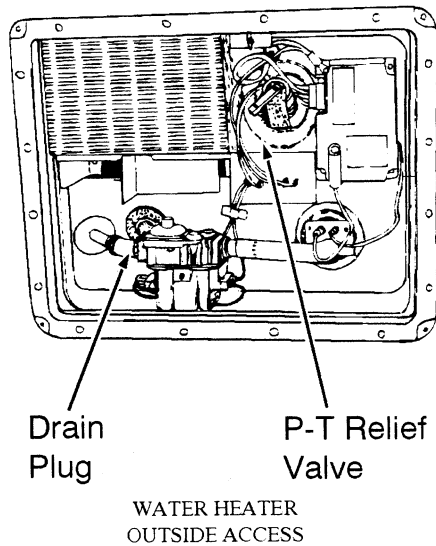

11. Operate and hold toilet flush lever until water is completely drained from toilet.

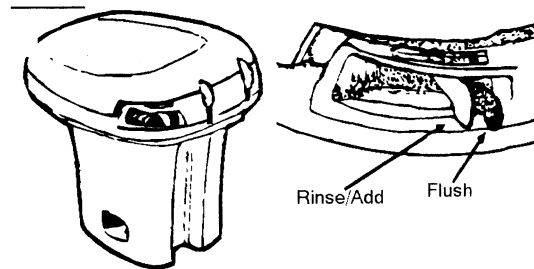

9. After water has stopped draining at all faucets and drain valves, connect a “blow-out” plug to the city water connection on the coach. Then use a hand pump or air compressor regulated to 30 psi or less to force air through the system. (A “blow-out” plug can be purchased at any Winnebago or Itasca dealer. P/N 701705-01-000.)

12. Now turn air pressure off and disconnect water purge adapters. Recap the city water connection to avoid contamination by dirt or insects.
13. Close all drain valves and faucets to avoid contamination by dirt or insects. Reinstall water heater drain plug and close P-T relief valve.
14. Pour about one cup of non-toxic RV antifreeze into the kitchen sink drain, bathroom sink drain and shower drain. This prevents any holding tank odors from entering the coach during storage.

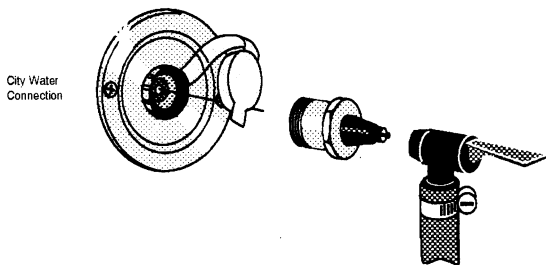

**WARNING**  
NEVER use automotive antifreeze/coolant in your RV water system. Auto antifreeze contains ethylene glycol which, if ingested, can cause blindness and can be fatal.

**CAUTION**  
Limit air pressure to 30 psi to avoid damage to pump or water lines.

*NOTE: DO NOT burst air into the system. This can damage the water pump. It is better to let air in slowly.*

10. Let air flow for five minutes until water is completely drained out of faucets and drain valves. Then close faucets one at a time.

It is not necessary to add antifreeze to the toilet since the flush valve will be closed.

Do not add automotive antifreeze or caustic chemicals such as bleach or laundry detergents into the toilet bowl or holding tanks. Although these products may have a deodorizing effect, they may damage plastic and rubber parts in the system.

*NOTE: As an alternative to totally draining the plumbing system, you may winterize tanks and lines by pumping non-*

*toxic RV antifreeze through the system. This product is available from your dealer and from most RV supply stores. Follow directions on the container to determine the correct amount to use for your coach. See "Water System Winterization Valve" on page 7-4 for instructions on injecting RV antifreeze into water lines.*

15. Place a bucket beneath the sewage drain valve outlet and re-drain the sewage and waste holding tanks of any clean water that entered during "blow-out" procedure.

Close dump valves to prevent valve shafts from rusting and to prevent entry by rodents and insects. Refit the dust cap onto the drain outlet.

Your drainage and fresh water systems are now totally winterized.

16. Have the vehicle chassis completely serviced and lubricated. Be sure radiator antifreeze protection level is sufficient for the lowest anticipated temperatures.
17. Wash and wax the coach.
18. Inspect all seams and seals around doors, windows, vents, and any other joints. Replace or repair any that are damaged. Sealing materials and compounds can be purchased from your dealer. Badly damaged weather seals may need to be replaced by your dealer.
19. Close all windows and roof vents. Protect all appliance vent openings from contamination by animals or insects (e.g. bird nests, wasp nests, etc.)
20. Lubricate all door hinges and locks.
21. Clean the interior of the coach. Dirt and stains are more easily removed when fresh.
22. Remove all foods and items that may cause odors.
23. Clean and defrost the refrigerator. Leave the door slightly ajar to allow any odors to dissipate. Place an open box of baking soda inside the refrigerator to help absorb odors.
24. Turn the furnace thermostat switch on the

bottom of the thermostat to OFF.

25. Turn auxiliary battery (Aux Batt) switch off. If your coach does not have an Aux Batt switch, disconnect all chassis and auxiliary battery cables.
26. Fully charge batteries.
27. Batteries must be kept to at least 80% charge to keep from freezing or sulfating. We recommend that you connect a battery charger and fully charge batteries at least once a month during long-term storage periods to maintain charge at 80% or greater. Turn Aux. Batt. switch off to avoid electrical arcing when attaching and detaching charger clamps.

### REMOVAL FROM STORAGE

1. Completely air out the motor home.
2. Have the entire LP gas system checked for leaks.
3. Check window operation.
4. Check cabinet and door hinges. Lubricate with penetrating oil, if necessary.
5. Close all faucets and drain valves that are open. If necessary, reconnect toilet water line and close flush valve.
6. Add a few gallons of water to the fresh water tank and check for leaks especially at junctions. Also make sure all hangers and supports are securely in place. Sanitize the water system as outlined under "Disinfecting the Fresh Water System" in Section 7.
7. Check operation of all faucets to be sure faucet washers have not hardened during storage.
8. Check sealing valve in the toilet for proper operation and lubricate with silicone spray.
9. Add water to the holding tank using the toilet flush pedal. Check to be sure dump valve seals tightly.
10. Check around all appliances for obstructions and ensure that all vent openings are clear.
11. Start refrigerator and check for proper cooling.
12. Clean paneling and counter surfaces and apply a thin coat of wax.
13. Replace batteries if necessary and check out electrical system to make sure all lights and

## INDEX

Exits, Emergency .....	1-5	LP Gas Furnace .....	8-8
Exterior Body Care .....	9-1	LP Gas Leaks .....	1-2, 5-4
Exterior Entertainment Center .....	8-11	LP Gas Level .....	8-6
Exterior Features .....	0-4	LP Gas Pressure Regulator .....	5-3
External (City Water) Connector .....	7-2	LP Gas Safety .....	5-1
External Power Cord (Shoreline).....	6-1	LP Gas Selection.....	5-1
<b>F</b>		LP Gas Tank, Air in the .....	5-2
Filling the Fuel Tank.....	2-2	LP Gas Tank, Refilling .....	5-2
Fire Extinguisher .....	1-5	LP Gas Tank System.....	5-2
Formaldehyde Warning .....	1-4	LP Gas, Travel with .....	5-2
Fresh Water Tank.....	7-1	LP Gas, Winter Use of .....	5-4
Disinfection of .....	7-1	<b>M</b>	
Drain .....	7-3	Microwave Oven.....	8-5
Filling .....	7-1	Mirrors .....	2-6
Fresh Water Toilet .....	8-12	Monitor Panel .....	8-6
Fuel Selection .....	2-2	Motor Aid Water Heater.....	8-8
Fuel Tank Capacity .....	2-2	Motor Home Operation Manual (Binder).....	0-1
Fuel Tank, Filling .....	2-2	Mountain Driving .....	4-6
Furnace , LP Gas .....	8-8	<b>N</b>	
<b>G</b>		Nighttime Driving.....	4-6
Gas Alarm, LP .....	1-2	<b>O</b>	
Gas Leaks, LP .....	5-4	Occupancy, Effects of Prolonged .....	4-7
General Warnings .....	1-1	Operating the Oven.....	8-4
Generator, Auxiliary 110-Volt .....	6-4, 6-5	Operation Manual (Binder), Motor Home ....	0-1
Generator Hourmeter .....	6-5	Operators Manual .....	0-1
Ground Fault Circuit Interrupter.....	6-3	Options and Equipment .....	0-1
<b>H</b>		Outlets , 110-Volt .....	6-3
Hazard Warning Flashers.....	2-3, 3-1	Oven Pilot .....	8-5
Heater, Automotive.....	2-8	Overload Protector, Thermal .....	6-2
Holding Tank Level Indicators .....	8-6	<b>P</b>	
Hourmeter, Generator .....	6-5	Parking Brake .....	2-3
Humidity and Condensation .....	4-7	Pilot, Lighting Oven .....	8-5
<b>I</b>		Power Converter .....	6-2
Instrument Panel .....	2-7	Power Roof Vent .....	8-13
Interior Care .....	9-2, 9-3	Pre-Travel Checklist .....	4-2
<b>J</b>		Preparing Vehicle for Storage .....	10-1
Jump Starting .....	3-2	Pressure Regulator, LP Gas .....	5-3
<b>K</b>		Prolonged Occupancy, Effects of .....	4-7
Keys .....	2-2	Pump Switch, Water .....	7-1
<b>L</b>		<b>Q</b>	
Lights .....	9-4	Quick Loading Checklist .....	4-4
Loading, Roof .....	4-2	<b>R</b>	
Loading the Vehicle .....	4-1	Radio/Cassette Player, Dash .....	2-8
Lounge Chairs.....	2-4	Radio Security Reminder, Sony.....	2-8
LP Gas Alarm .....	1-2	Range and Oven.....	8-4
		Range Hood .....	8-5



Recovery Towing.....	3-2
Refrigerator.....	8-1
Regulator, LP Gas.....	5-3
Relief Valve, Water Heater.....	8-7
Removal from Storage.....	10-4
Reporting Safety Defects.....	0-2
Restraints, Child.....	2-6
Roof Loading.....	4-2
Roof Maintenance.....	9-1
Roof Vent, Power.....	8-13

### S

Safe Use of LP Gas System.....	5-1
Safety Defects, Reporting.....	0-2
Safety Precautions.....	3-1
Seat, Driver.....	2-4
Seat Belts and Child Restraints.....	2-5
Seats.....	2-4
Security Reminder, Sony Radio.....	2-8
Selecting Fuel Types, LP.....	5-1
Service Assistance.....	0-2
Severe Weather Information.....	4-5
Sewer Hook-Ups, Using On-Site.....	7-3
Shoreline, Connecting the.....	6-1
Shower Valve Pressure Bleedoff.....	7-2
Signal Amplifier, TV Antenna.....	8-10
Sink, Stainless Steel.....	9-3
Sleeping Facilities.....	8-11
Slider Windows.....	8-13
Spare Tire.....	3-1
Speed Control (Cruise).....	2-8
Spots and Stains.....	9-2
Start Switch, Aux.....	2-8
Starting and Stopping the Engine.....	2-2
Step, Entrance.....	2-3
Storage, Preparing Vehicle for.....	10-1
Storage, Removal from.....	10-4
Stripes and Decals.....	9-1
Suspension Alignment and Tire Balance.....	9-4

### T

Table and Countertop Surfaces.....	9-3
Tank , Fresh Water Filling.....	7-1
*Tank Capacities, Water and Holding.....	7-1, 7-4
Thermal Breaker.....	6-2
Tire, Spare.....	3-1
Tire Balance, Suspension Alignment and.....	9-4
Tire Changing.....	3-1
Tires.....	9-4
Toilet, Fresh Water.....	8-12
Towing, Recovery.....	3-2
Trailer Towing.....	4-2

Trailer Wiring Connector.....	6-8
Travel Tips.....	4-4
Travel with LP Gas.....	5-2
TV Antenna.....	8-9
TV & Cable Hook-Ups,.....	8-10
TV Signal Amplifier.....	8-10

### U

Underbody Care.....	9-1
Upholstery.....	9-2
Using On-Site Sewer Hook-Ups.....	7-3

### V

Vehicle Certification Label (VIN).....	0-3
Vehicle Maintenance.....	9-4
Vents, Power Roof.....	8-13
Vinyl Fabrics.....	9-2
Vinyl Wallboard.....	9-3

### W

Wall Clock, Quartz.....	8-13
Warnings:	
Carbon Monoxide.....	1-4
Driving.....	1-1
Formaldehyde.....	1-4
Fuel & LP Gas.....	1-1
LP Gas Leaks.....	1-2
LP Gas Alarm.....	1-2
Electrical.....	1-3
Loading.....	1-3
Maintenance.....	1-4
Warranty.....	0-2
Water and Holding Tank Levels.....	8-6
Water Drain Valves.....	7-4
Water Heater, Motor Aid.....	8-8
Water Heater.....	8-7
Water Heater By-Pass Valve.....	8-8
Water Heater Capacity.....	8-8
Water Line Drain Valves.....	7-3, 7-5
Water Pump.....	7-1
Water Pump Switch.....	7-1, 8-6
Water Tank, Disinfection of.....	7-1
Water Tank Filling.....	7-1
Wheel Nuts.....	3-2
Windows, Cleaning.....	9-3
Windows, Slider.....	8-13
Windows, Doors and.....	9-3
Windows, Emergency Exit.....	1-5
Windshield Washers and Wipers.....	9-4
Winter Use of LP Gas.....	5-4
Winterizing.....	10-1



**IMPORTANT  
SERIAL NUMBERS**

Motor Home (Coach): Year \_\_\_\_\_ Model \_\_\_\_\_ Serial \_\_\_\_\_  
Chassis: Make \_\_\_\_\_ Serial (VIN) \_\_\_\_\_

Roof Air Conditioner:	Brand _____	Model _____	Serial _____
Furnace:	Brand _____	Model _____	Serial _____
Water Heater:	Brand _____	Model _____	Serial _____
Power Converter:	Brand _____	Model _____	Serial _____
110-Volt Generator:	Brand _____	Model _____	Serial _____
Range:	Brand _____	Model _____	Serial _____
Microwave Oven:	Brand _____	Model _____	Serial _____
Refrigerator:	Brand _____	Model _____	Serial _____
Television:	Brand _____	Model _____	Serial _____
Video Cassette Player:	Brand _____	Model _____	Serial _____

**EMERGENCY INFORMATION**

**Dealer**

Name \_\_\_\_\_

Address \_\_\_\_\_

Phone \_\_\_\_\_

**INSURANCE POLICY**

Company \_\_\_\_\_

Policy Number \_\_\_\_\_

Phone \_\_\_\_\_





